



**CADprofi 2018.05**



## ✓ CADprofi – layer management based on the Open BIM classification

At the request of users, an additional layer standard "CADprofi Plus", was introduced. In this standard objects and symbols are inserted on separate layers.

Examples of layers in the HVAC module:

- 2DH\_OBJ – layer for objects
- 2DH\_SYM – layer for symbols

Layer management

Automatically (in accordance with selected standard)

Layer standard

CADprofi Plus

You can add and edit your own layer standard.

Enable prefix '3D' for 3D objects

Extended layer name

Layer color from system

Insert objects on current layer

Fixed layer

## ✓ CADprofi Electrical – new line category

New line category – *Measurement and control technology* has been added to the *Cable, cable trays – schematic* command, including:

- eBUS communication.
- Electric cable.
- Low-voltage cable.

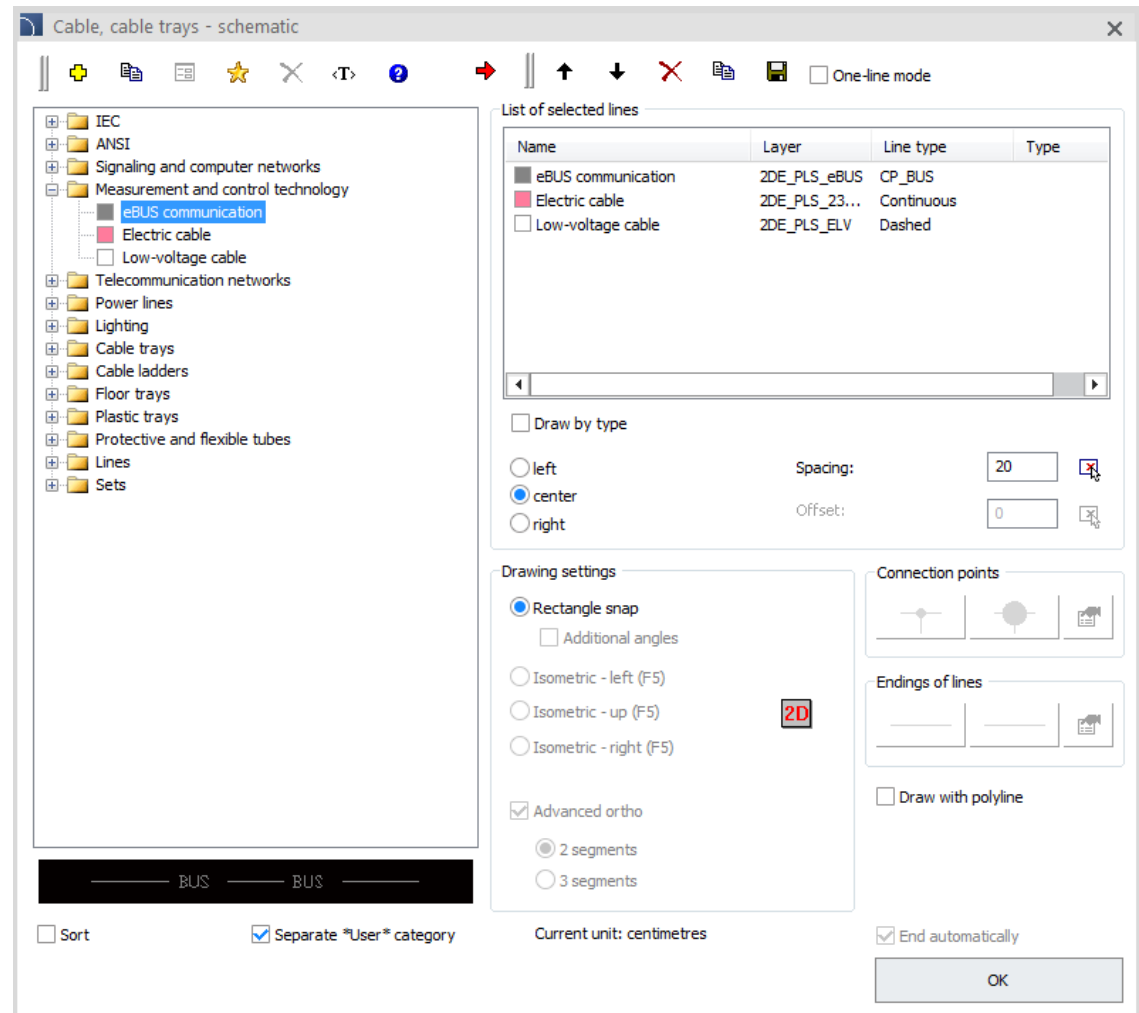

## ✓ CADprofi Mechanical – additional JIS and ISO standards

New standardized elements have been added to the program, including:

- JIS G 3192 – L-shape equal angles, L-shape unequal angles, U-shape (rolled), T-shape (hot rolled).
- JIS G 3192-1 - L-shape unequal angles.
- JIS G 3192-2 – L-shape unequal angles.
- JIS G 3350B – Z-shape.
- JIS G 3192 H – H-shape (Hot rolled wide-flange steel beams - Dimensions).
- JIS G 3192 I – I-shape (Hot rolled).
- JIS G-3466 – Welded square/rectangular structural tubing (For precision applications).
- JIS G 3191A – Round steel rod.
- JIS G 3191 B – Square steel rod.
- JIS 3194 – Rectangular steel rod.
- JIS 3191C – Hexagon steel rod.
- ISO 1035-3 – Flat steel bar (Hot rolled).
- ISO 657-1 – L-shape equal angles.
- ISO 657-2 – L-shape unequal angles.
- ISO 657-11 – U-shape (rolled).
- ISO 657-21 – T-shape (hot rolled).
- ISO 657-15 – I-shape (Hot rolled).
- ISO 10799-2 – Welded round/square/rectangular structural tubing (Cold formed welded structural hollow sections).
- ISO 12633-2 – Welded round/square/rectangular structural tubing.
- ISO 1035-1 – Round stainless steel bar (Hot rolled).
- ISO 1035-2 – Square steel bar (Hot rolled).

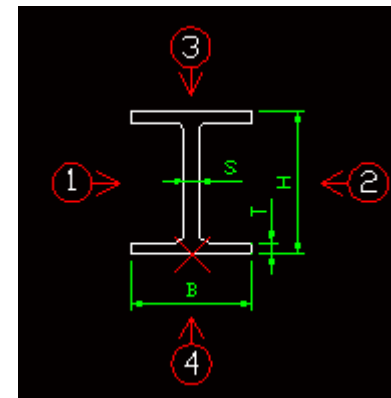
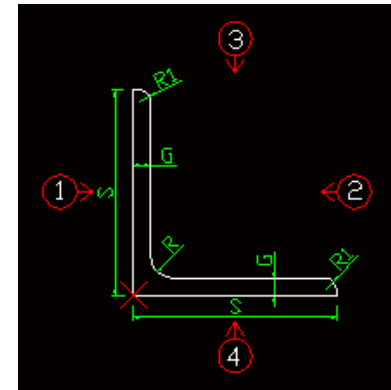



# CADprofi

## ✓ CADprofi HVAC & Piping – addition of water meter chambers to the program

Rectangular and round water meter chambers have been added to the program.

Name	SW	DW	HW	SZ	HZ	DZ
S9/12	90.0	120.0	190.0	110.0	210.0	140.0
S9/15	90.0	150.0	190.0	110.0	210.0	170.0
S9/18	90.0	180.0	190.0	110.0	210.0	200.0
S9/21	90.0	210.0	190.0	110.0	210.0	230.0
S9/24	90.0	240.0	190.0	110.0	210.0	260.0
S9/27	90.0	270.0	190.0	110.0	210.0	290.0
S9/30	90.0	300.0	190.0	110.0	210.0	320.0
S9/33	90.0	330.0	190.0	110.0	210.0	350.0
S9/36	90.0	360.0	190.0	110.0	210.0	380.0
S9/39	90.0	390.0	190.0	110.0	210.0	410.0
S12/12	120.0	120.0	190.0	140.0	210.0	140.0
S12/15	120.0	150.0	190.0	140.0	210.0	170.0
S12/18	120.0	180.0	190.0	140.0	210.0	200.0
S12/21	120.0	210.0	190.0	140.0	210.0	230.0
S12/24	120.0	240.0	190.0	140.0	210.0	260.0
S12/27	120.0	270.0	190.0	140.0	210.0	290.0
S12/30	120.0	300.0	190.0	140.0	210.0	320.0
S12/33	120.0	330.0	190.0	140.0	210.0	350.0
S12/36	120.0	360.0	190.0	140.0	210.0	380.0
S12/39	120.0	390.0	190.0	140.0	210.0	410.0
S15/15	150.0	150.0	190.0	170.0	210.0	170.0
S15/18	150.0	180.0	190.0	170.0	210.0	200.0

View and insertion point

2D  Hiding 1  Side  --

System  Repeat the command

Current unit: centimetres

Object style

OK



# CADprofi

## ✓ CADprofi HVAC & Piping – new lines categories

New line categories – *Renewable heat sources* and *Cooling liquids* has been added to the *Pipes – scheme* command.

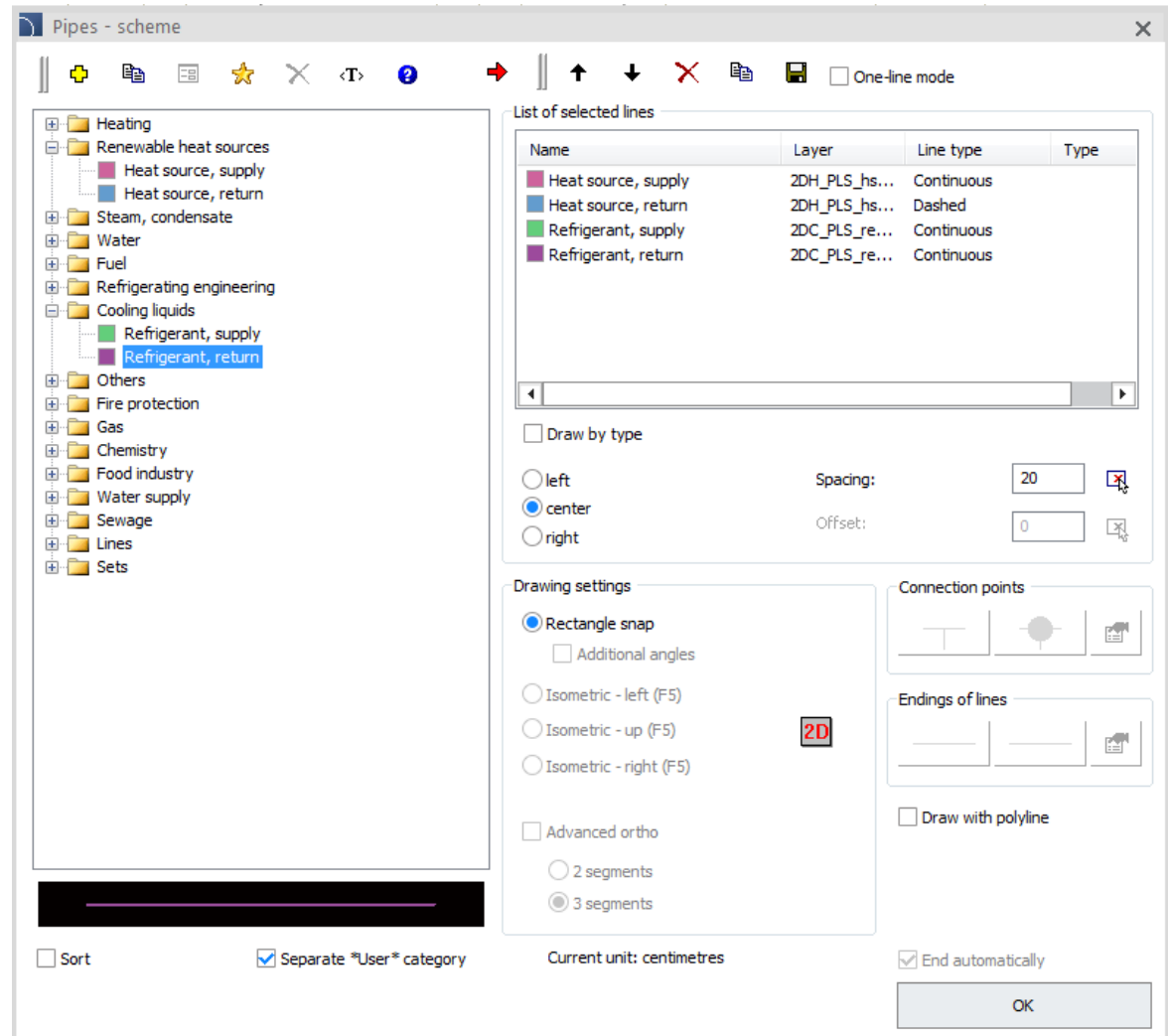

## ✓ CADprofi HVAC & Piping – extension of the program library

Additional symbols and object have been added to the program, including:

- Filterer
- Shower
- Water heating element
- Pipe break
- Safety assembly heat generator
- Three-way thermostatic valve
- Safety assembly heat generator
- Solar protection vessel
- Wärmepumpe
- Air separator
- Additional wall and ceiling fans
- Protective louvre
- Additional ground air grille
- Additional exhaust and supply air outlets
- Slotted outlets

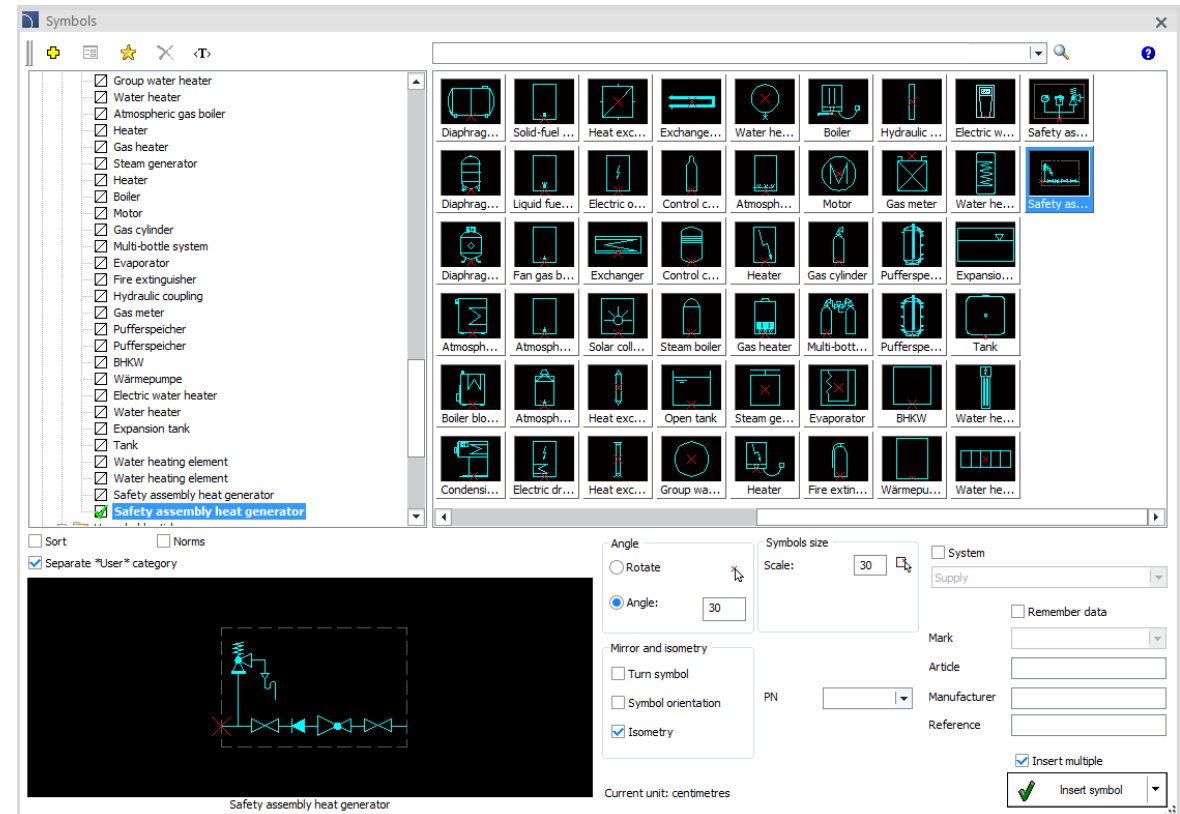



# CADprofi

✓ Update of manufacturers' libraries:







**CADprofi**



**CADprofi 2018.03**

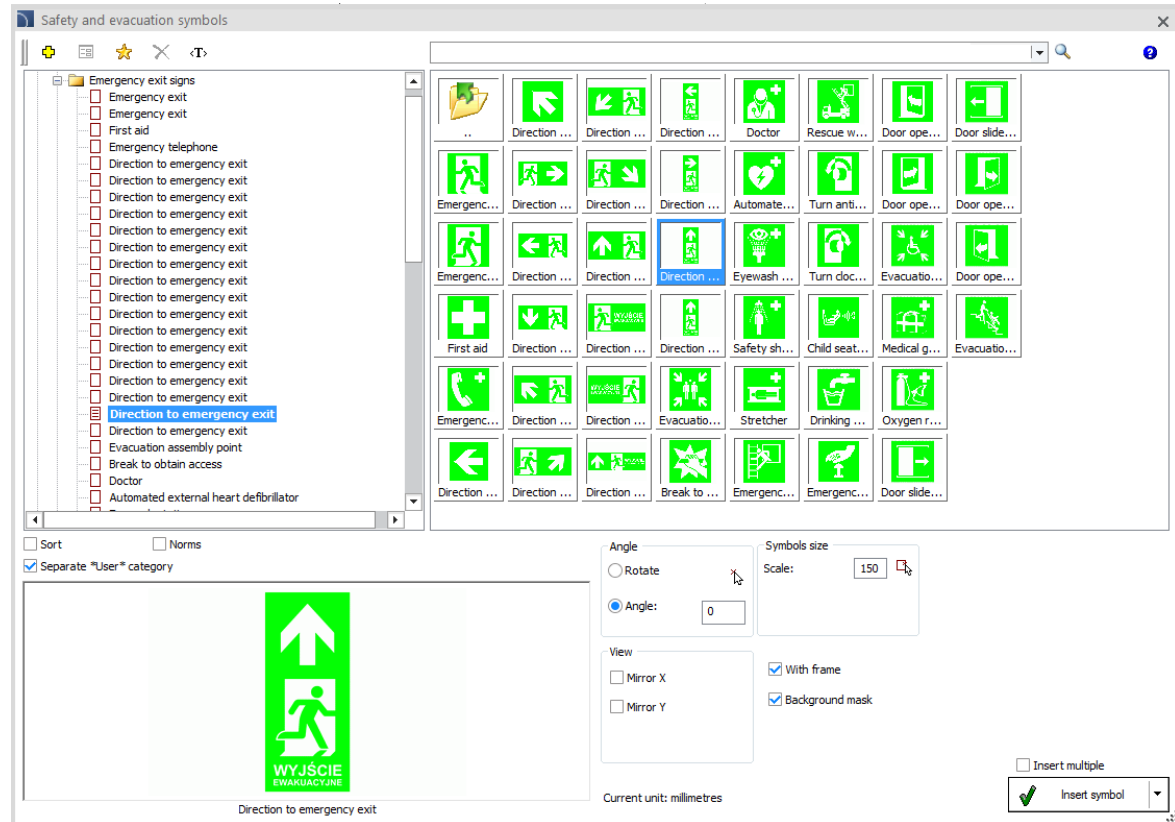

## ✓ CADprofi Architectural – extension of the evacuation symbols database

Additional symbols prepared in accordance to the ISO 7010 and PN-92/N-01256 standards have been added to the program.



## ✓ CADprofi Architectural – the possibility to determine the mounting height

*Furniture and equipment* command has been extended with the possibility to specify the mounting height (H1 dimension) bathroom-kitchen fittings and others (front view).

L=	300	
H=	500	
H1=	450	

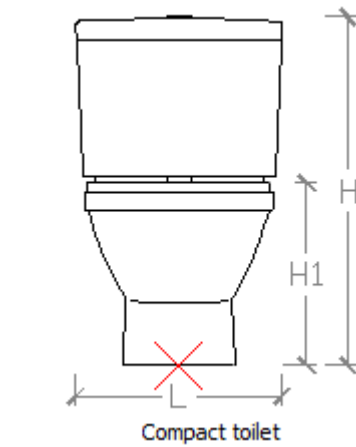

## ✓ CADprofi Architectural – the ability to hide the door leaf layer

The possibility to hide the door leaf layer (CP\_DOORON layer) has been added to the program. This view allows for easier design of evacuation plans and fire protection installations.

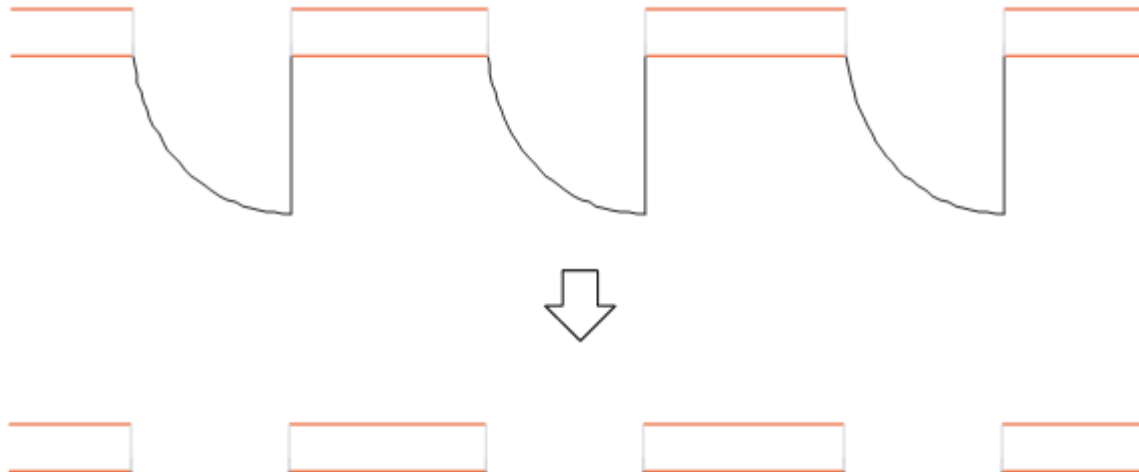

## ✓ CADprofi Electrical – extension of the fire protection symbols

Additional fire protection symbols (e.g. smoke exhaust system, smoke extraction button, ventilation switch and multisensor detectors) have been added to the program.

Mark	Multisensor smoke and flame
Article	F - multisensor alarm with flasher So - multisensor alarm with sounder Sp - multisensor alarm with sounder and speech messages FSp - multisensor alarm with flasher, sounder and speech messages
Manufacturer	

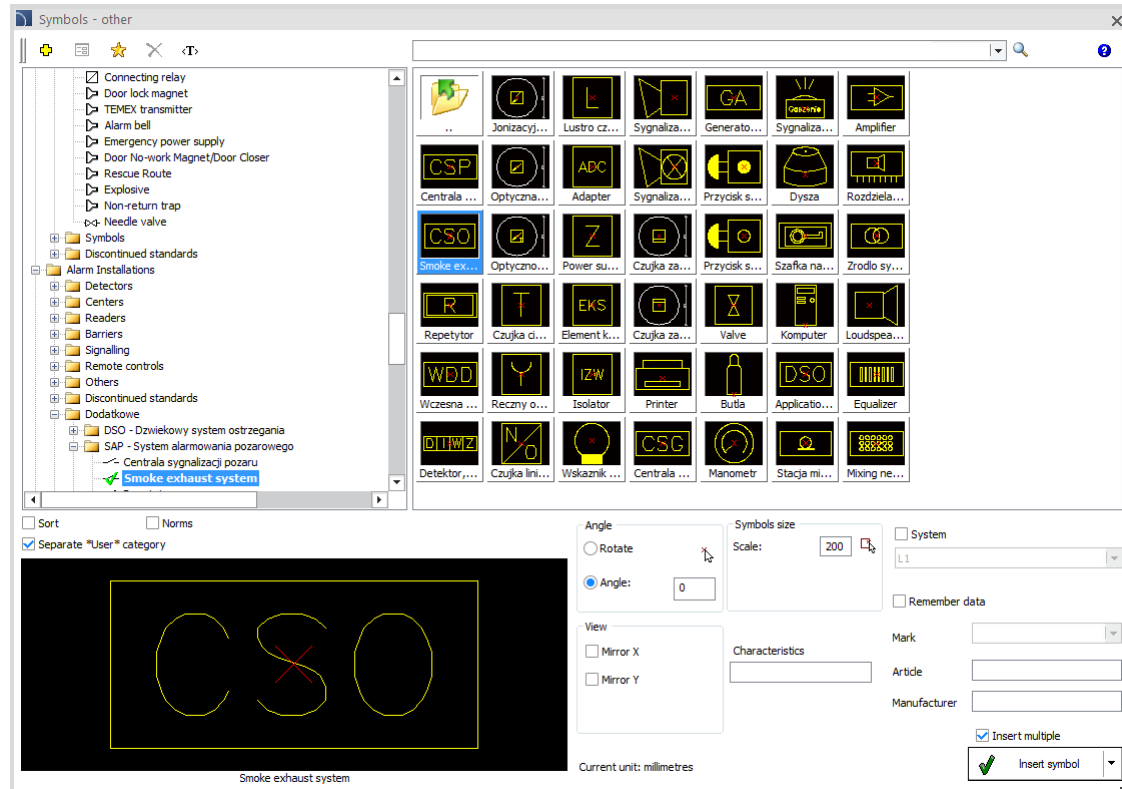

The screenshot displays the 'Symbols - other' library window in CADprofi Electrical. The library contains various fire protection symbols, including:

- Connecting relay
- Door lock magnet
- TELEX transmitter
- Alarm bell
- Emergency power supply
- Door No-work Magnet/Door Closer
- Rescue Route
- Explosive
- Non-return trap
- Needle valve
- Smoke exhaust system (highlighted)
- DSO - Dźwiękowy system ostrzegania
- SAP - System alarmowania pożarowego
- Centrala sygnalizacji pożaru

The preview window shows a symbol for the 'Smoke exhaust system' (CSO) with a red 'X' in the center. The symbol is displayed on a black background with a yellow border. The preview window also shows the 'Smoke exhaust system' label below the symbol.

The interface includes a search bar, a list of symbols, and a preview window. The preview window shows the symbol 'CSO' with a red 'X' in the center, indicating the 'Smoke exhaust system'. The preview window also shows the 'Smoke exhaust system' label below the symbol.

The interface also includes a search bar, a list of symbols, and a preview window. The preview window shows the symbol 'CSO' with a red 'X' in the center, indicating the 'Smoke exhaust system'. The preview window also shows the 'Smoke exhaust system' label below the symbol.

The interface also includes a search bar, a list of symbols, and a preview window. The preview window shows the symbol 'CSO' with a red 'X' in the center, indicating the 'Smoke exhaust system'. The preview window also shows the 'Smoke exhaust system' label below the symbol.



# CADprofi

## ✓ CADprofi HVAC & Piping – addition of sprinklers to the program

Upright, pendent, horizontal sidewall and dry pendent sprinklers have been added to the program.

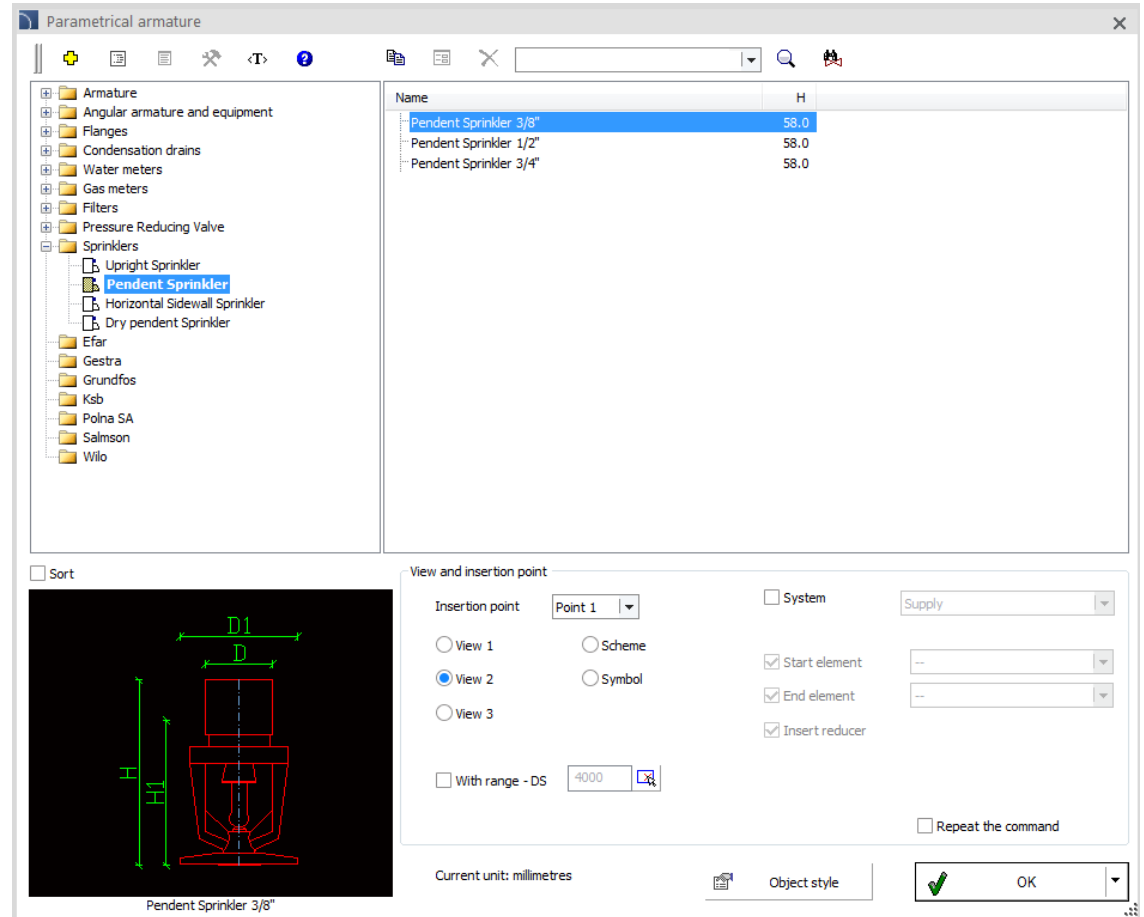



# CADprofi

## ✓ CADprofi HVAC & Piping - addition of roof blowers to the program

Venture Industries roof blowers have been added to the program.

The screenshot displays the 'Outlets' panel in the CADprofi software. The panel is divided into three main sections:

- Left Panel (Tree View):** Shows a hierarchical list of outlets under the 'Blowers' folder. The 'Roof blower' item is selected and highlighted in blue.
- Center Panel (Table):** A table listing various roof blower models with their diameters (D) and capacities. The 'HCTB/4-315' model is selected.
- Right Panel (Objects to insert):** A panel for selecting objects to insert into the drawing, currently empty.

The table in the center panel contains the following data:

Name	D	Capacity
Roof blower		
160	100.0	245 m <sup>3</sup> /h
185	125.0	385 m <sup>3</sup> /h
225	150.0	850 m <sup>3</sup> /h
250	160.0	1300 m <sup>3</sup> /h
315	200.0	1680 m <sup>3</sup> /h
355	250.0	2650 m <sup>3</sup> /h
Venture Industries-HCT-230V		
HCTB/4-315	315.0	1930 m <sup>3</sup> /h
HCTB/4-355	355.0	2680 m <sup>3</sup> /h
HCTB/4-400	400.0	3700 m <sup>3</sup> /h
HCTB/4-450	450.0	5600 m <sup>3</sup> /h
HCTB/4-500	500.0	7100 m <sup>3</sup> /h
HCTB/4-560	560.0	9820 m <sup>3</sup> /h
HCTB/4-630	630.0	13000 m <sup>3</sup> /h
Venture Industries-HCT-400V		
HCTT/4-315	315.0	1930 m <sup>3</sup> /h
HCTT/4-355	355.0	2680 m <sup>3</sup> /h
HCTT/4-400	400.0	3700 m <sup>3</sup> /h
HCTT/4-450	450.0	5600 m <sup>3</sup> /h
HCTT/4-500	500.0	7100 m <sup>3</sup> /h

At the bottom left, a technical drawing of the selected 'HCTB/4-315' model is shown. The drawing includes dimensions: A (height), A1 (height), D (diameter), and D1 (diameter).

At the bottom right, the 'View and insertion point' dialog is open, showing options for '2D', 'View 1', and 'View 2'. The '2D' option is selected. The 'System' checkbox is unchecked, and the 'Supply air' dropdown is set to 'Supply air'. The 'Repeat the command' checkbox is unchecked. The current unit is 'millimetres'. The 'Object style' dropdown is set to 'Object style'. The 'OK' button is highlighted.



# CADprofi

## ✓ CADprofi – layer management

A possibility to manage layers have been added to the program. Management is available in the *CADprofi – Options* command.

**Layer management**

Automatically (in accordance with selected standard)

Layer standard  
CADprofi

You can add and edit your own layer standard.

Enable prefix '3D' for 3D objects

Extended layer name

Layer color from system

Insert objects on current layer

Fixed layer

Edit layer standard: Standard 1

BIM classes and layers from 'Standard 1' standard

Choose BIM class from object...

Selected BIM class

IFC class name: IfcAnnotation

Internal class name: hs:CpIsoHS

Selected BIM class layer

Objects layer for selected class: Insulation50

Set layer for selected BIM class: Insulation50

Filter list of layers (display only similar layers)

Layer properties

Line color: 131

Line weight: 0.18 mm

Line type: continuous

Sort  Show only main BIM classes

OK





# CADprofi

✓ Update of manufacturers' libraries:



✓



# CADprofi

## ✓ Adjustment to many base CAD programs

CADprofi 2018.03 has been adjusted to work with latest CAD programs, including: 4MCAD 19 and ARES 2018.

CADprofi 2018 currently works with many base CAD programs including: AutoCAD (since the 2000 version), BricsCAD, GstarCAD, IntelliCAD, progeCAD, ZWCAD, ARES Commander Edition and others.

The AutoCAD logo, with "AutoCAD" in red and a registered trademark symbol.

The ZWCAD logo, with "ZWCAD" in blue and a green leaf-like graphic above the "W".

The GstarCAD logo, with "GstarCAD" in blue and yellow, and the tagline "An Alternative CAD System" below it.

The BricsCAD logo, featuring a blue stylized "B" shape above the word "BRICSCAD" in blue.

The progeSOFT logo, featuring a blue globe with a yellow vertical bar and a yellow triangle above it, with the text "progeSOFT" below.

The IntelliCAD logo, featuring a purple diamond shape with a yellow vertical bar and a yellow triangle above it, with the text "IntelliCAD" below.



**CADprofi**



# **CADprofi 2018**

Summary of main changes made to the program since the CADprofi 2017.01 version.



# CADprofi

## Table of contents:

- [General commands \(affects all modules\)](#)
- [CADprofi Architectural](#)
- [CADprofi Electrical](#)
- [CADprofi Mechanical](#)
- [CADprofi HVAC & Piping](#)
- [Manufacturers libraries](#)
- [Adjustment to CAD programs](#)



# CADprofi

## ✓ CADprofi – Open BIM

Classification of objects and management of layers based on Open BIM (IFC classification) has been added to the program.



[Video – Open BIM](#)

Data printing from current drawing

↑ ↓ ✕ 👤 ? Title Report data

You can sort data and specify width of columns

Name	BIM class	Sum	--
Bed	IfcFurnishingElement	1	pcs.
Binding circular ceiling lights	IfcLamp	15	pcs.
Binding circular wall lighting	IfcLamp	10	pcs.
Binding light triple	IfcLamp	6	pcs.
Binding lighting, raster	IfcLamp	10	pcs.
Binding single light	IfcLamp	2	pcs.
Cabinet	IfcFurnishingElement	3	pcs.
Cabinet	IfcFurnishingElement	1	pcs.
Cabinet	IfcFurnishingElement	1	pcs.
Car	IfcCivilElement	1	pcs.
Chair	IfcFurnishingElement	4	pcs.
Chest of drawers	IfcFurnishingElement	3	pcs.
Chest of drawers	IfcFurnishingElement	2	pcs.
Combustion duct	IfcDistributionElement	3	pcs.
Connection	IfcSpaceHeater	5	pcs.
Control valve	IfcDistributionControlElement	2	pcs.



# CADprofi

## ✓ Icons for dark interface

CADprofi toolbars and ribbons have been customized for dark interface that is used on some newer CAD programs (AutoCAD, ZWCAD and others).

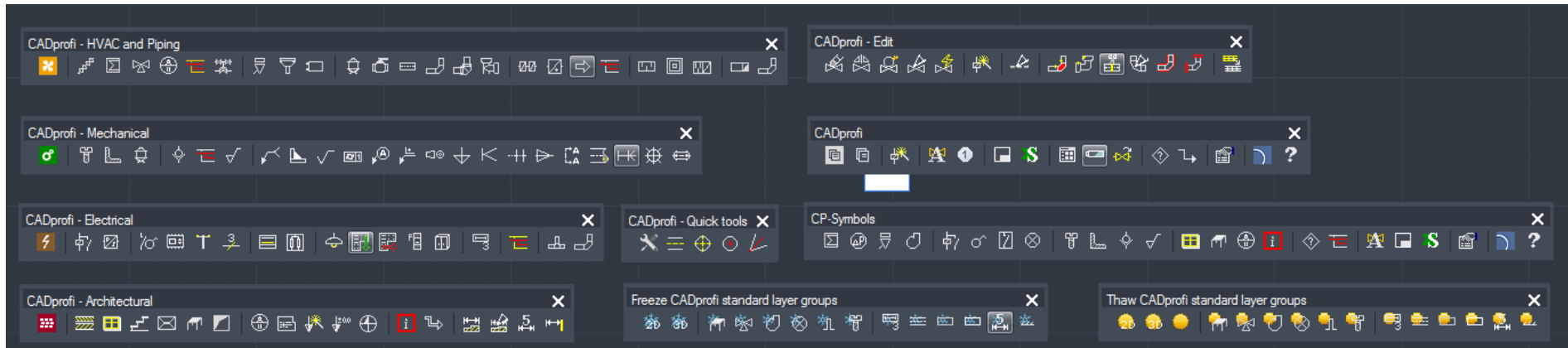

## ✓ CADprofi - Explode

New command *CADprofi - Explode*  has been added to the program. This command explodes the indicated CADprofi blocks, allowing to freely edit the drawing without the loss of information from the exploded elements.

In case of indicating the *Insert 'Infoblock'* option the program creates a special block, to which all data from the exploded element will be taken over. This block will be placed on layer that is not visible on printouts, but it's attributes will be included in specifications.

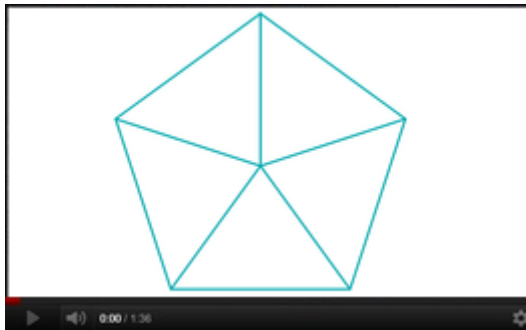

[Video – 'CADprofi Explode' + Infoblocks](#)

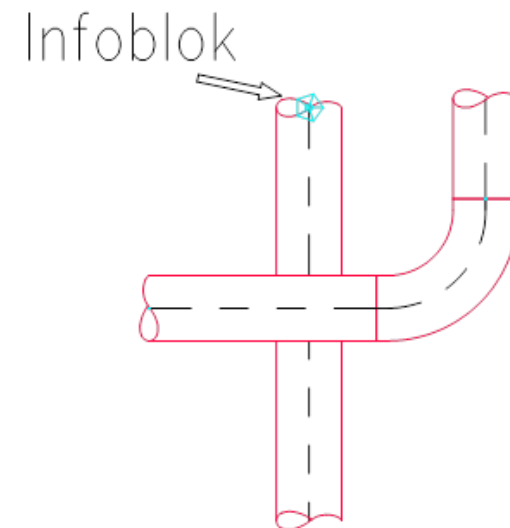
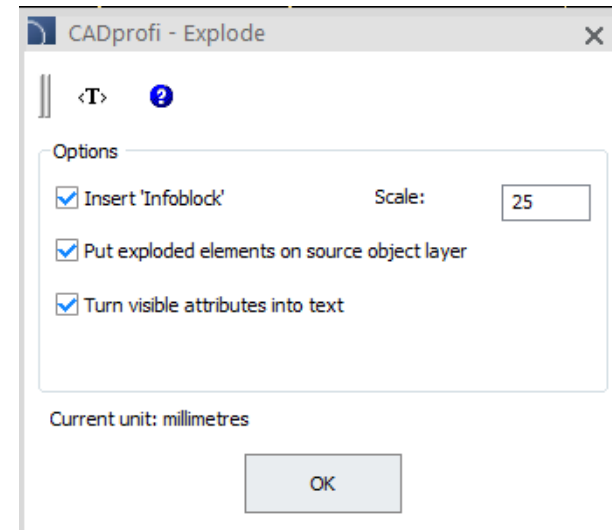

## ✓ Infoblocks in CADprofi program libraries

*Infoblocks* have been added to CADprofi libraries. They contain a set of attributes that user can freely fill. Thanks to Infoblocks user can insert a special block into the drawing whose attributes will be included in specifications, but the block itself will not be visible on printouts.

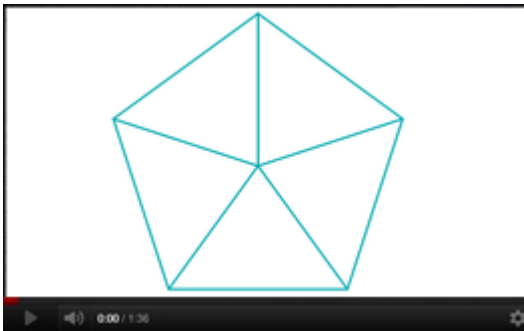

[Video – 'CADprofi Explode' + Infoblocks](#)

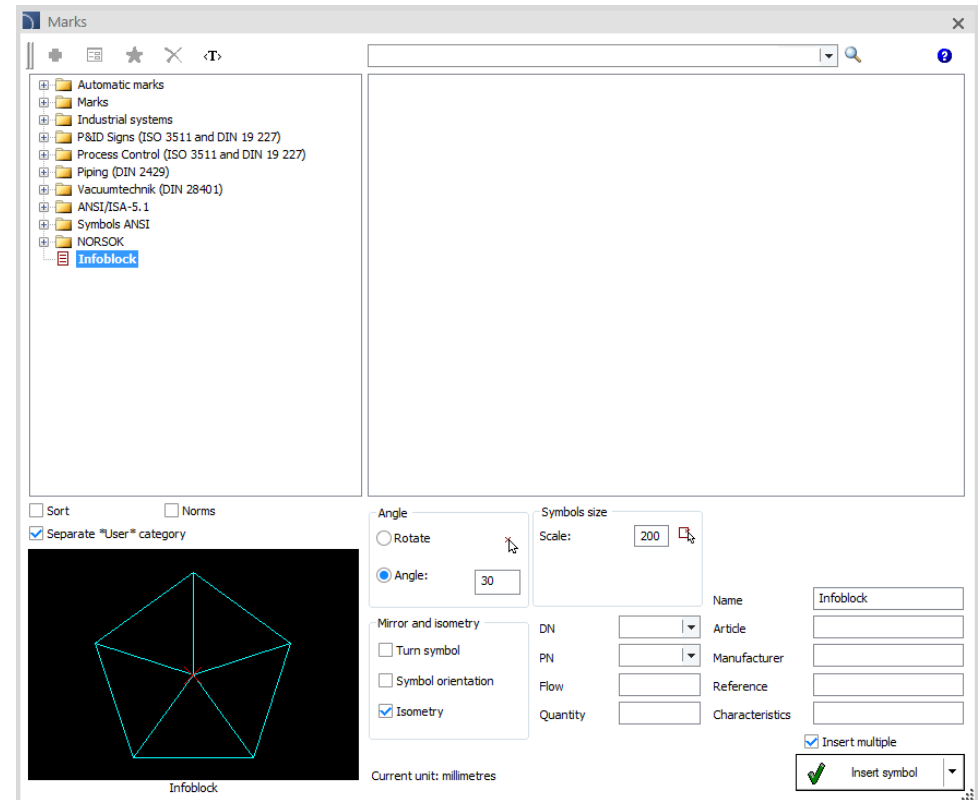





## ✓ Using commands from the context menu

In selected CAD programs, some commands are available in the context menu (right mouse button):

- Attributes and descriptions,
- Quick edit.

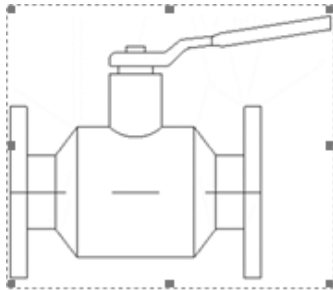
1. Indicate an object on the drawing



2. Click the right mouse button 

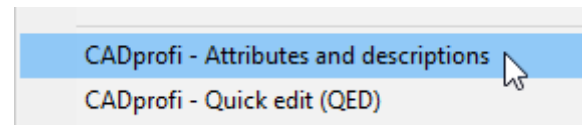
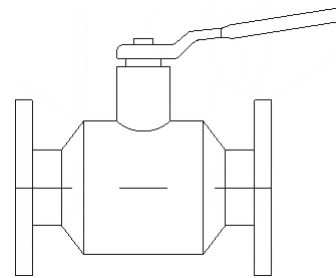



# CADprofi

## ✓ Repeat the command. Insert multiple

For some dialog windows an additional options that enhance functionality have been added:

- **Repeat the command** - allowing for automatic repetition of the last command without the need to manually run the command dialog window from menu or toolbar.

Repeat the command

- **Insert multiple** - allowing for multiple insertion of the selected object to the drawing with bypassing the dialog window. In this case, the command can be cancelled by pressing the *Esc* key.

Insert multiple



# CADprofi

## ✓ CADprofi Architectural – holes in wall barriers

Holes in wall barriers (unbuilt door hole and unbuilt window hole) have been added to the program.

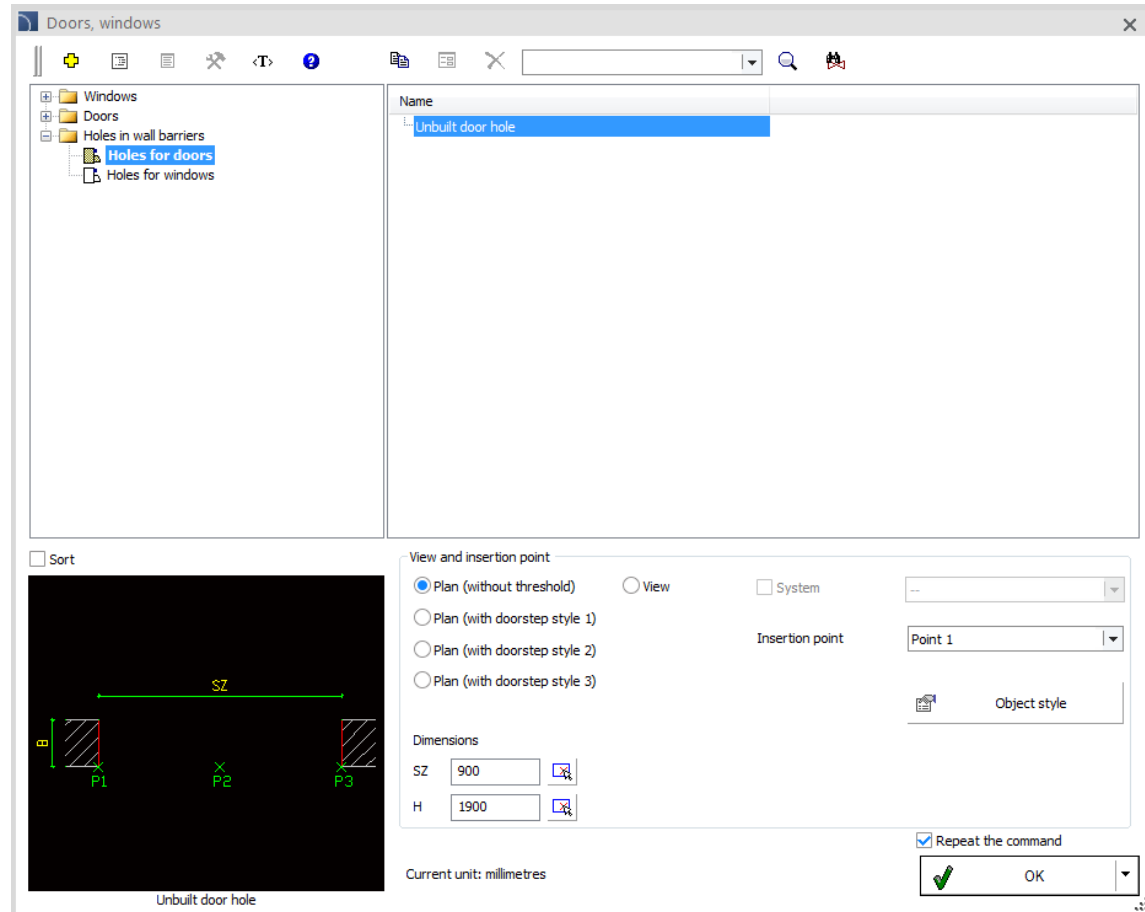

## ✓ CADprofi Electrical – changes in the *Switchgear* command

Functionality of the command has been extended by:

- Possibility to insert items from the list, thanks to which it is possible to insert to the drawing many elements.
- Extension of the switchgear database (distributors under plaster/on plaster and distributors with counters).
- Addition of IT cabinets (multimedia cabinets, RACK19" cabinets with system elements)
- Addition of system cabinets (wall mounted, flush mounted, floor standing with system elements).
- Addition of mounting rails DIN TH35, busbars and plastic wiring ducts.
- Switchgear blocks have got defined intelligent connection points that allow automatic positioning of products inserted into switchboard, such as building system elements and various electrical apparatus.

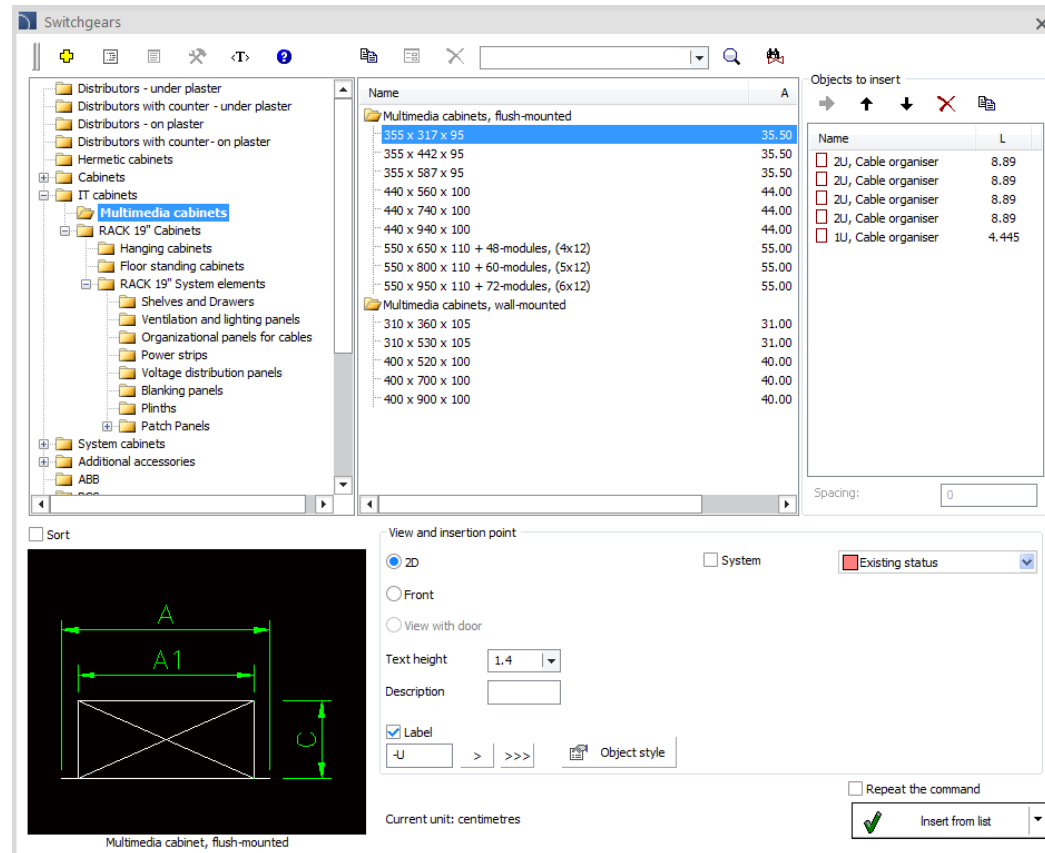

## ✓ CADprofi Electrical – changes in the *PLC controllers* command

The PLC controller command has been extended with the possibility to specify the input/output size. The way to describe and insert additional inputs/outputs has been rebuilt and adapted to the new functionality.

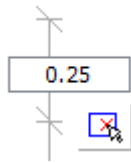
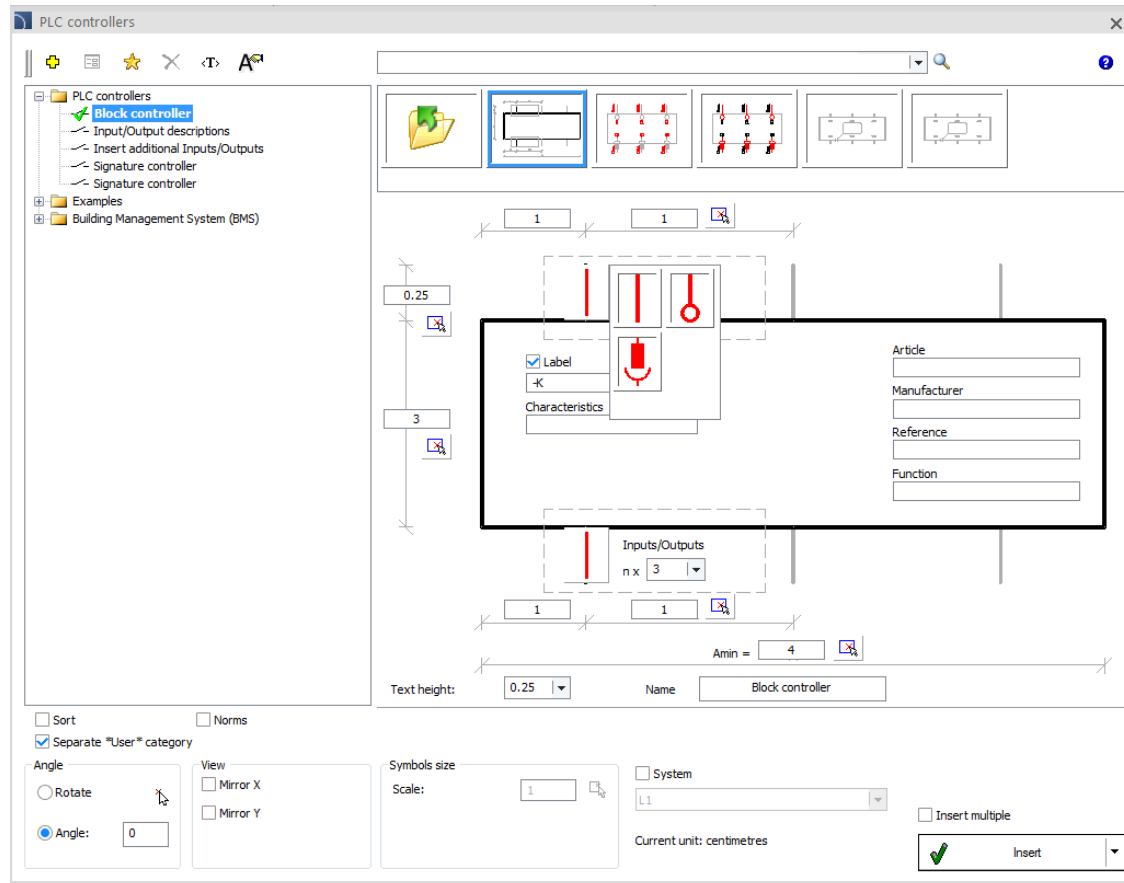
The screenshot shows the 'PLC controllers' command window in CADprofi Electrical. The main workspace displays a schematic diagram of a PLC controller. The controller is represented by a large rectangular block with various input and output terminals. The terminals are labeled with '1' and '0.25'. The controller block has a 'Label' field with a checkmark, a 'Characteristics' field, and an 'Inputs/Outputs' field with a dropdown menu set to 'n x 3'. To the right of the controller block, there are several input fields for 'Article', 'Manufacturer', 'Reference', and 'Function'. The bottom control panel includes options for 'Sort', 'Norms', 'Separate "User" category', 'Angle' (Rotate and Angle), 'View' (Mirror X and Mirror Y), 'Symbols size' (Scale), 'System' (L1), 'Current unit: centimetres', and an 'Insert' button with a green checkmark.

## ✓ CADprofi Electrical – cooperation with DIALux program

A possibility to export rooms do DIALux have been added to the program. Thanks to this we will receive a building outline and the project structure with room names imported from CADprofi.

Program also allows to import luminaires from DIALux. During import all luminaires will be replaced with standard CADprofi blocks and information about them (name, type) will be taken from DIALux and replaced with appropriate attributes.



[Watch how CADprofi works with DIALux](#)

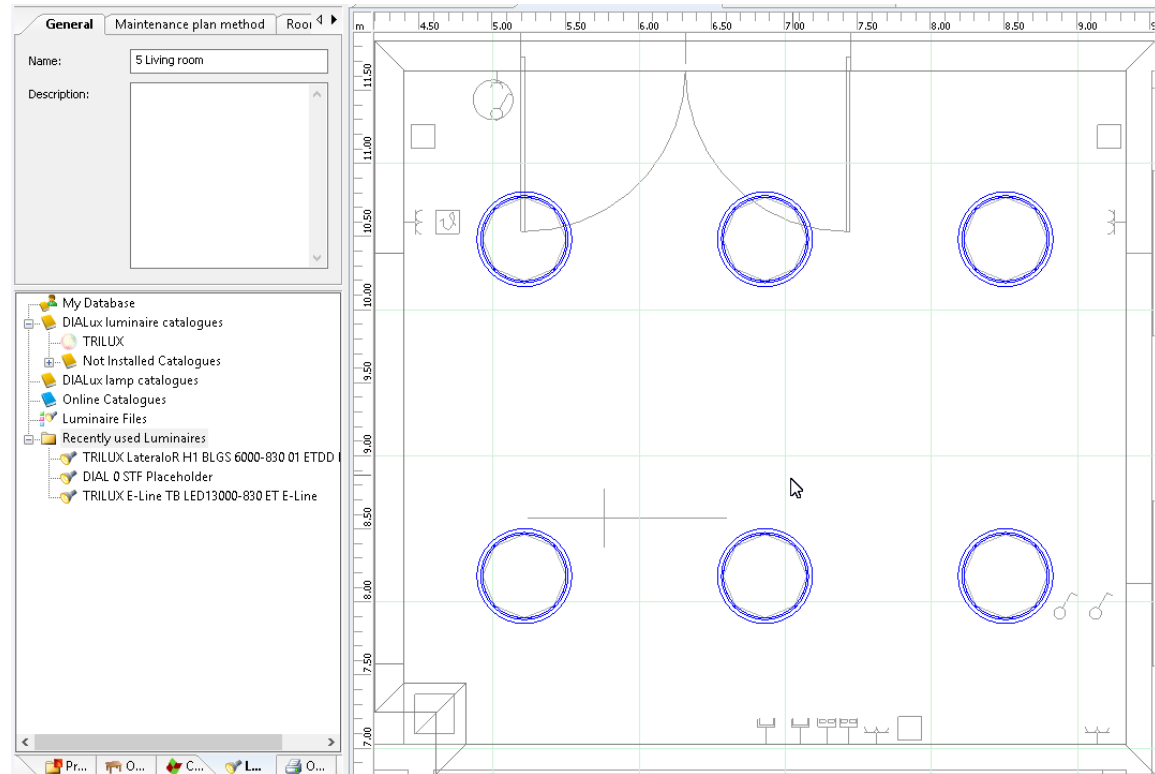



# CADprofi

## ✓ CADprofi Electrical – extension of the current difference disconnectors database

New current difference disconnectors (type AC, A, B) have been added to the program.

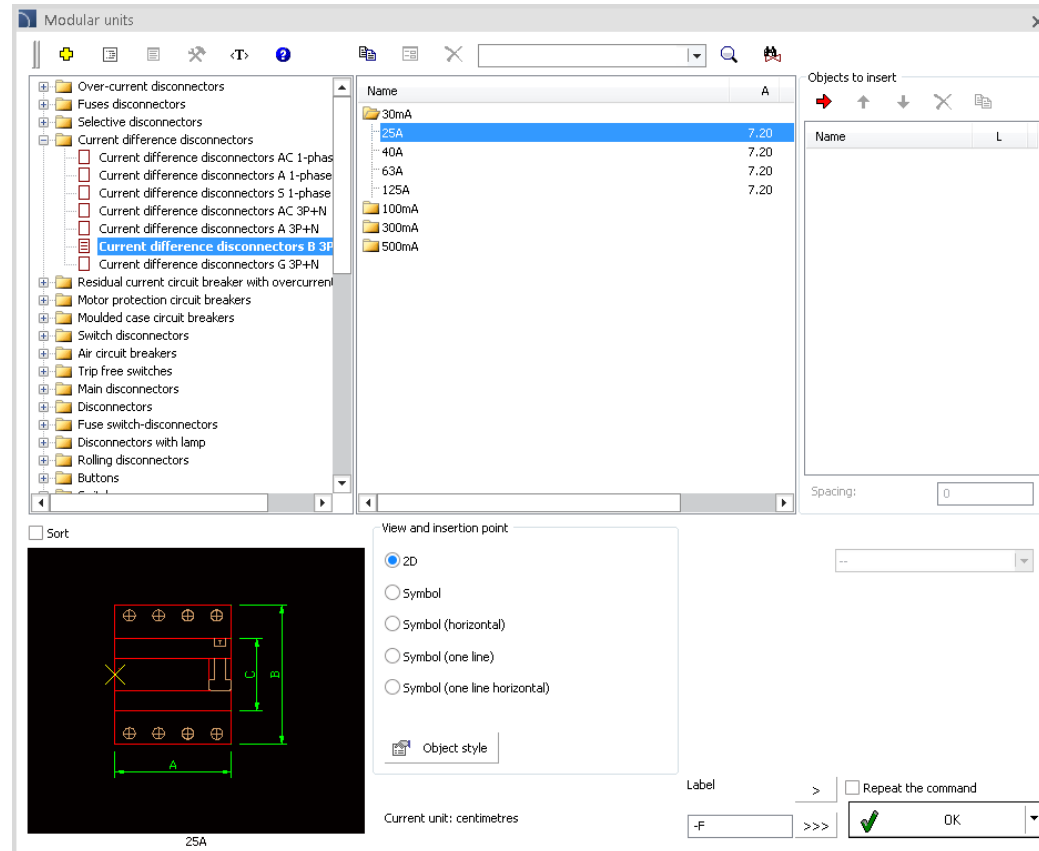

## ✓ CADprofi Electrical – changes in the *Objects and lighting* command



Functionality of the command has been extended by:

- Possibility to insert items from the list, thanks to which it is possible to insert to the drawing many elements with specified spacing.
- Possibility to repeat the command.

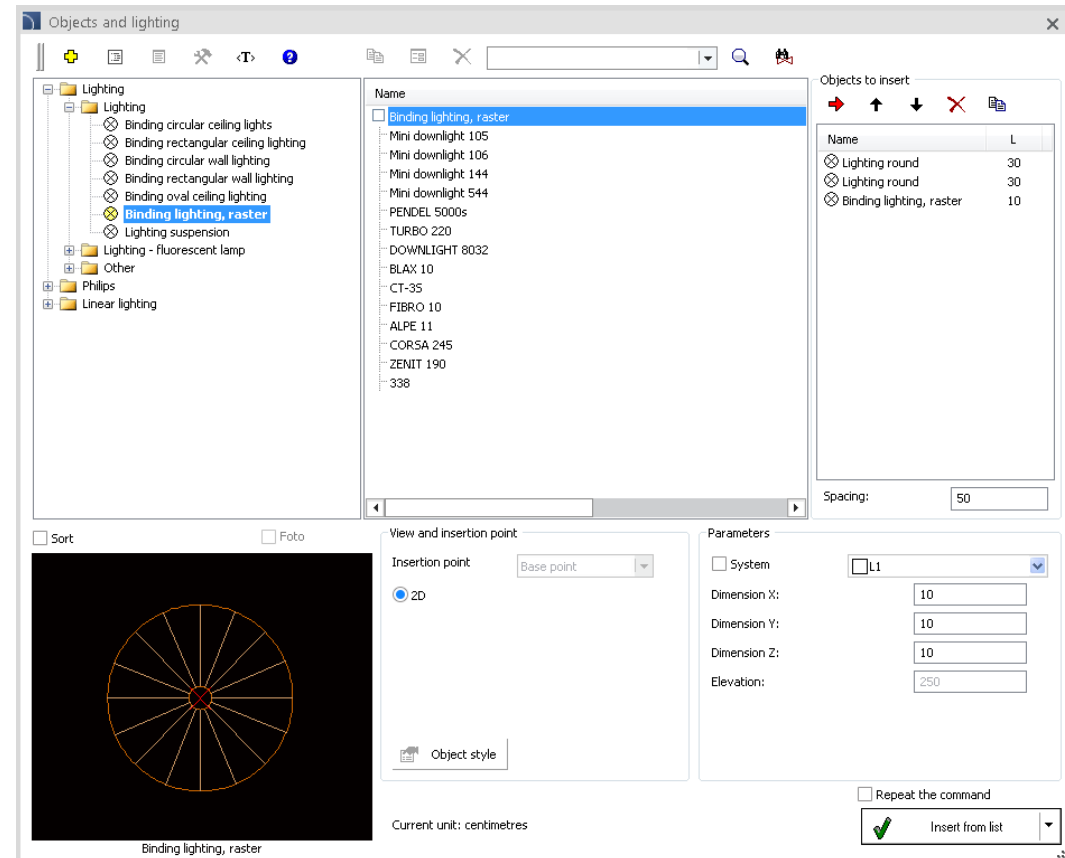



## ✓ CADprofi Electrical – scheme library extension

Additional symbols, potential & circuit lines and sample schemes have been added to the program, including:

- electrical symbols (IEC, NFPA);
- vertical and horizontal complex symbols (NFPA);
- potential and circuit lines (IEC, ANSI);
- vertical and horizontal schemes templates (ANSI).

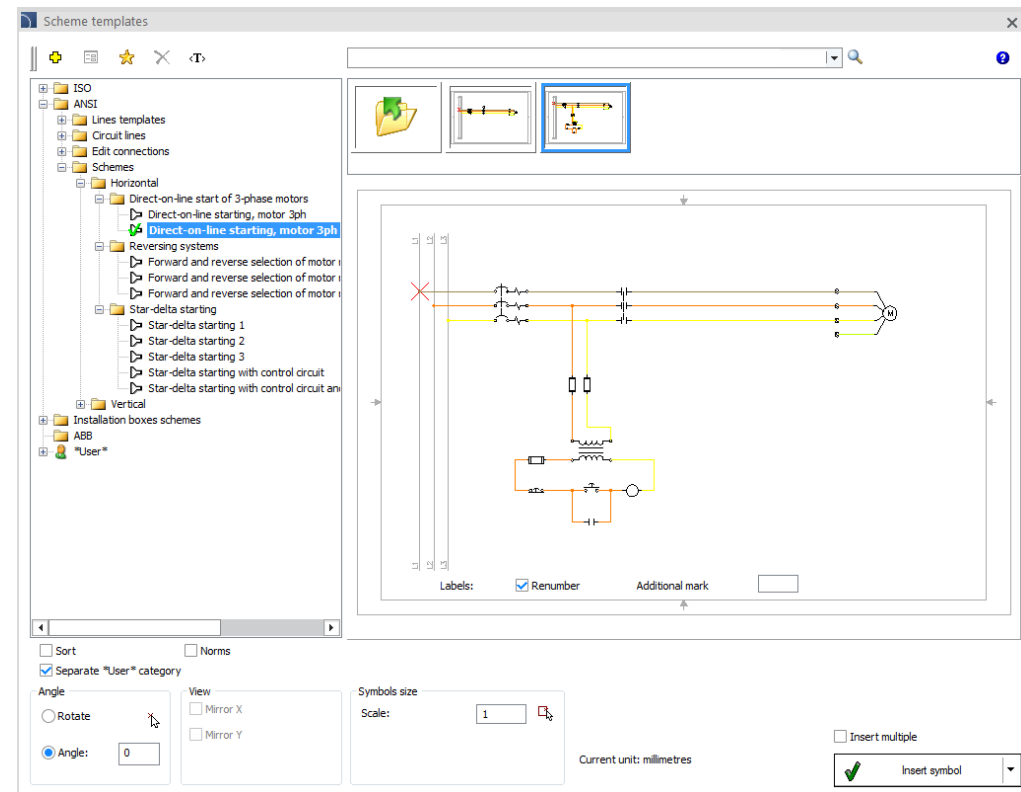

## ✓ CADprofi Electrical – extension of the modular apparatus library

Additional symbols and modular apparatus elements have been added to the program, including:

- Residual current circuit breaker with overcurrent protection 3-phase;
- Disconnectors with lamp 2-pole;
- Switch for panel mounting;
- Changover switch for panel mounting;
- Switches;
- Modular analogue and digital ammeter;
- Modular analogue and digital voltmeter;
- Installation relay;
- Interface relay;
- Time relay, flush mount version;
- Time relay for starting;
- Priority relay;
- Astronomical & digital time switch with weekly & yearly program;
- Shunt trip and undervoltage release;
- Front and side mountable auxiliary contact,
- Rotary handle,
- Direct and door handle,
- Residual-current boxes, characteristics A, AC, B,
- Selective residual-current boxes A, AC, B;
- Two states control lamp;
- Fuse modules;
- Semiconductor heaters and electrical fans;
- Auxiliary contact for motor contactor.

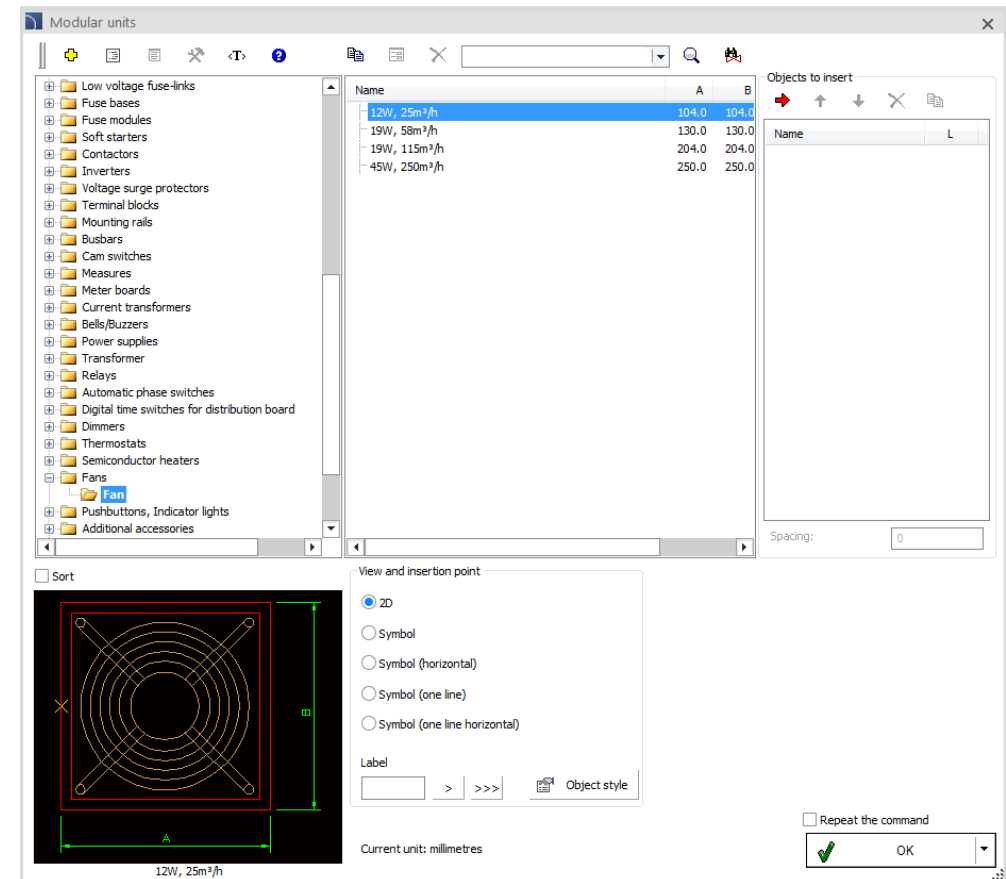

Additional signal cables and lighting have been added to the program.



# CADprofi

## ✓ CADprofi Mechanical – ability to specify the type of steel in profiles

An ability to specify the type of steel (material) in steel profiles have been added to the program.

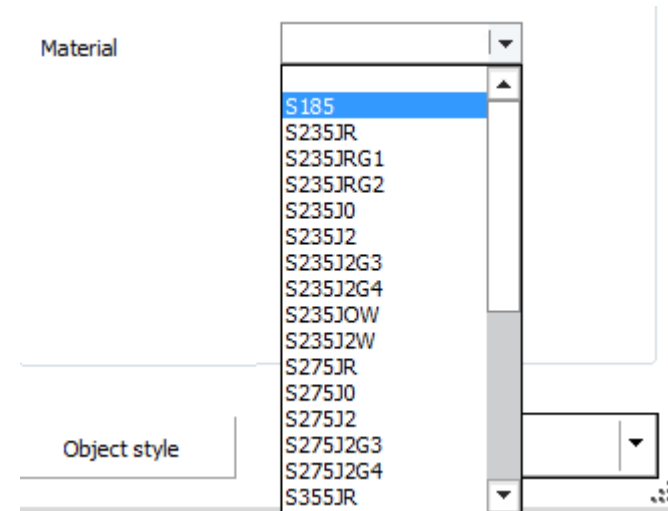

## ✓ CADprofi Mechanical – additional DIN, EN, ISO, PN standards

New standardized elements have been added to the program, including:

- DIN EN ISO 2342 - Slotted headless screw with shank,
- DIN EN ISO 8735 - Parallel pin with internal thread,
- DIN EN ISO 8746 - Grooved pin with round head,
- DIN EN ISO 8765 – Hexagon head bolt with metric fine pitch thread product A and B,
- DIN EN 14399-6 - Plain washer, chamfered, hardened and tempered for high-strength structural bolting,
- DIN EN 14399-8 - System HV - Hexagon fit bolt
- DIN EN 27435 - Slotted set screw with long dog point,
- DIN 920 – Slotted pan head screws with small head,
- DIN 921 - Slotted pan head screws with large head,
- DIN 923 – Slotted pan head screws with shoulder,
- DIN 927 – Slotted shoulder screws,
- DIN 986 – Prevailing torque type hexagon domed cap nuts,
- DIN 6888 – Woodruff key,
- DIN 6912 – Hexagon socket head cap screws with centre, with low head,
- DIN 7349 – Plain washers for bolts with heavy clamping sleeves,
- DIN 7603 – Sealing ring,
- DIN 7968 - Hexagon fit bolt,
- DIN 7984 – Hexagon socket head cap screws with low head,
- ISO 2342 - Slotted headless screw with shank,
- ISO 4766 - Slotted set screws with flat point,
- ISO 7041 - Prevailing torque type hexagon nut,
- ISO 7043 - Prevailing torque type hexagon nut with flange,
- ISO 7044 - Prevailing torque type hexagon nut with flange,
- ISO 7719 - Prevailing torque type hexagon nut,
- EN 14399-8 - System HV - Hexagon fit bolt.
- PN-73/H-93460.01 (L-shape equal angles).

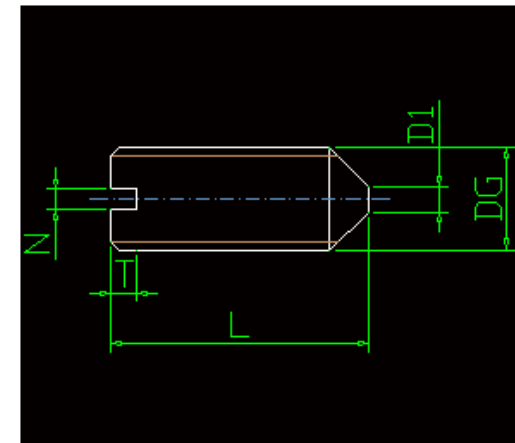
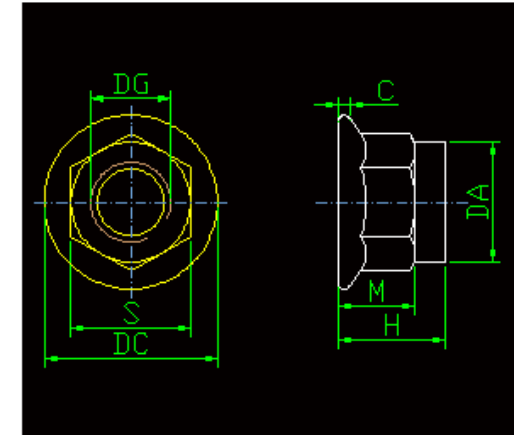

## ✓ CADprofi HVAC & Piping – addition of heat exchangers to the library

Do biblioteki programu dodano wymienniki ciepła, w tym:

- heat exchangers Shell & Tube;
- plate type heat exchangers;
- plate type heat exchangers two pass.

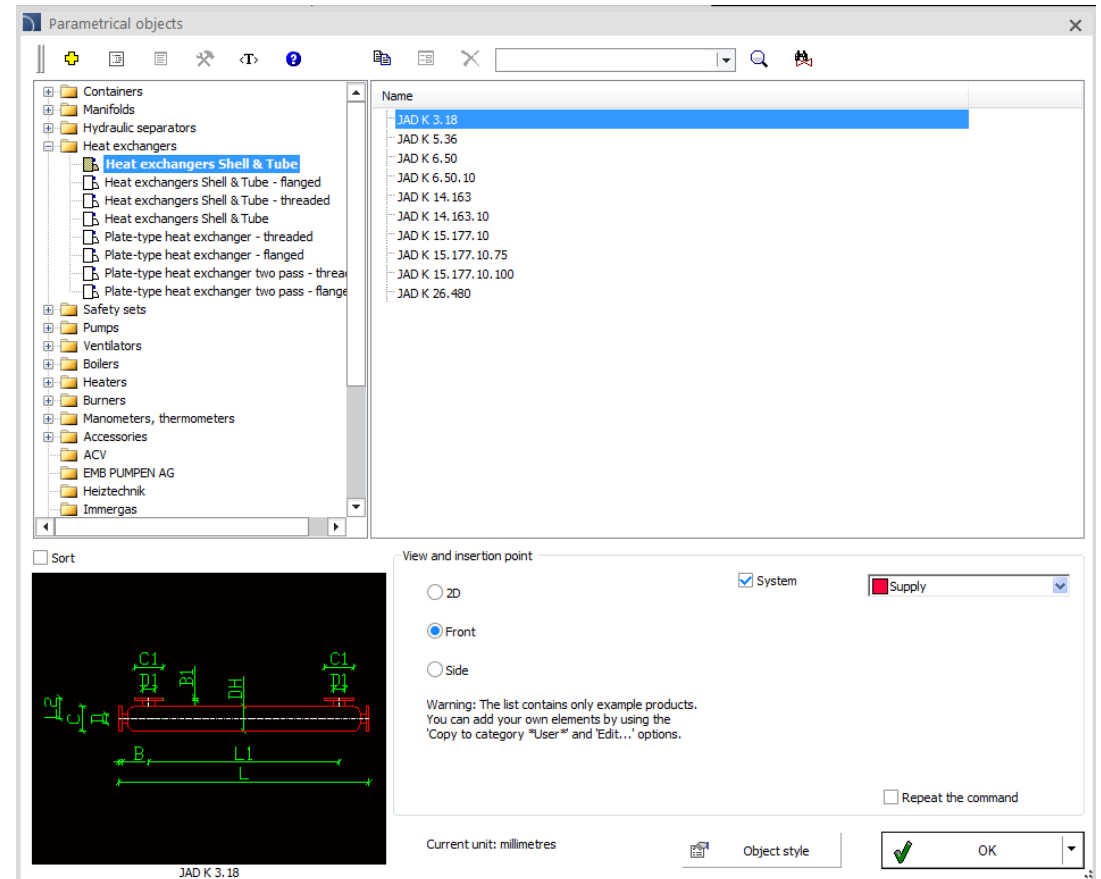

## ✓ CADprofi HVAC & Piping - addition of supply-exhaust air central plants to the library

Supply-exhaust air central plants have been added to the library, including:

- cross flow exchanger;
- cross-flow exchanger with mixing box.

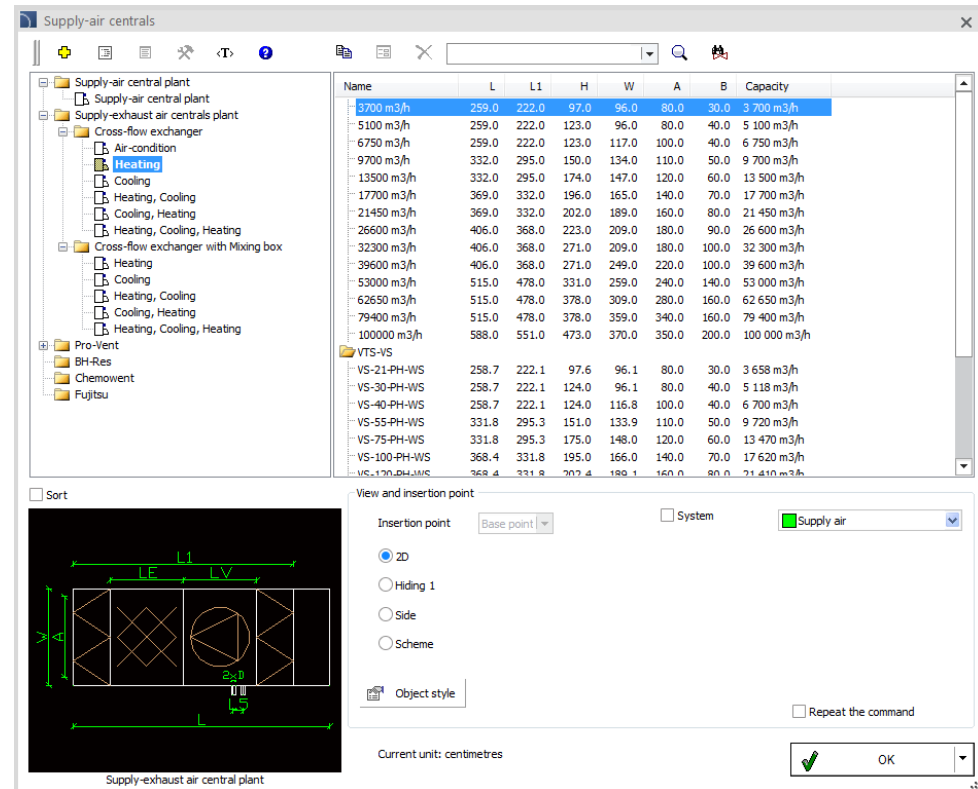

The screenshot displays the 'Supply-air centrals' library window. On the left, a tree view shows the hierarchy of plant types, including 'Supply-air central plant', 'Supply-exhaust air centrals plant', 'Cross-flow exchanger', and 'Cross-flow exchanger with Mixing box'. The main table lists various plant models with their capacity and dimensions.

Name	L	L1	H	W	A	B	Capacity
3700 m3/h	259.0	222.0	97.0	96.0	80.0	30.0	3 700 m3/h
5100 m3/h	259.0	222.0	123.0	96.0	80.0	40.0	5 100 m3/h
6750 m3/h	259.0	222.0	123.0	117.0	100.0	40.0	6 750 m3/h
9700 m3/h	332.0	295.0	150.0	134.0	110.0	50.0	9 700 m3/h
13500 m3/h	332.0	295.0	174.0	147.0	120.0	60.0	13 500 m3/h
17700 m3/h	369.0	332.0	196.0	165.0	140.0	70.0	17 700 m3/h
21450 m3/h	369.0	332.0	202.0	189.0	160.0	80.0	21 450 m3/h
26600 m3/h	406.0	368.0	223.0	209.0	180.0	90.0	26 600 m3/h
32300 m3/h	406.0	368.0	271.0	209.0	180.0	100.0	32 300 m3/h
39600 m3/h	406.0	368.0	271.0	249.0	220.0	100.0	39 600 m3/h
53000 m3/h	515.0	478.0	331.0	259.0	240.0	140.0	53 000 m3/h
62650 m3/h	515.0	478.0	378.0	309.0	280.0	160.0	62 650 m3/h
79400 m3/h	515.0	478.0	378.0	359.0	340.0	160.0	79 400 m3/h
100000 m3/h	588.0	551.0	473.0	370.0	350.0	200.0	100 000 m3/h
VTS-VS							
VS-21-PH-WS	258.7	222.1	97.6	96.1	80.0	30.0	3 658 m3/h
VS-30-PH-WS	258.7	222.1	124.0	96.1	80.0	40.0	5 118 m3/h
VS-40-PH-WS	258.7	222.1	124.0	116.8	100.0	40.0	6 700 m3/h
VS-55-PH-WS	331.8	295.3	151.0	133.9	110.0	50.0	9 720 m3/h
VS-75-PH-WS	331.8	295.3	175.0	148.0	120.0	60.0	13 470 m3/h
VS-100-PH-WS	368.4	331.8	195.0	166.0	140.0	70.0	17 620 m3/h
VS-170-PH-WS	368.4	331.8	202.4	180.1	160.0	80.0	21 410 m3/h

The bottom section shows a detailed view of a 'Supply-exhaust air central plant' with a schematic diagram and dimensions. The diagram includes labels for 'L1', 'L2', 'L3', 'L4', 'L5', 'L6', 'L7', 'L8', 'L9', 'L10', 'L11', 'L12', 'L13', 'L14', 'L15', 'L16', 'L17', 'L18', 'L19', 'L20', 'L21', 'L22', 'L23', 'L24', 'L25', 'L26', 'L27', 'L28', 'L29', 'L30', 'L31', 'L32', 'L33', 'L34', 'L35', 'L36', 'L37', 'L38', 'L39', 'L40', 'L41', 'L42', 'L43', 'L44', 'L45', 'L46', 'L47', 'L48', 'L49', 'L50', 'L51', 'L52', 'L53', 'L54', 'L55', 'L56', 'L57', 'L58', 'L59', 'L60', 'L61', 'L62', 'L63', 'L64', 'L65', 'L66', 'L67', 'L68', 'L69', 'L70', 'L71', 'L72', 'L73', 'L74', 'L75', 'L76', 'L77', 'L78', 'L79', 'L80', 'L81', 'L82', 'L83', 'L84', 'L85', 'L86', 'L87', 'L88', 'L89', 'L90', 'L91', 'L92', 'L93', 'L94', 'L95', 'L96', 'L97', 'L98', 'L99', 'L100'. The current unit is set to centimetres.

## ✓ CADprofi HVAC & Piping – addition of safety sets to the library

Safety sets used in central heating, hot utility water and for boilers that protect against dangerous pressure rise have been added to the program.

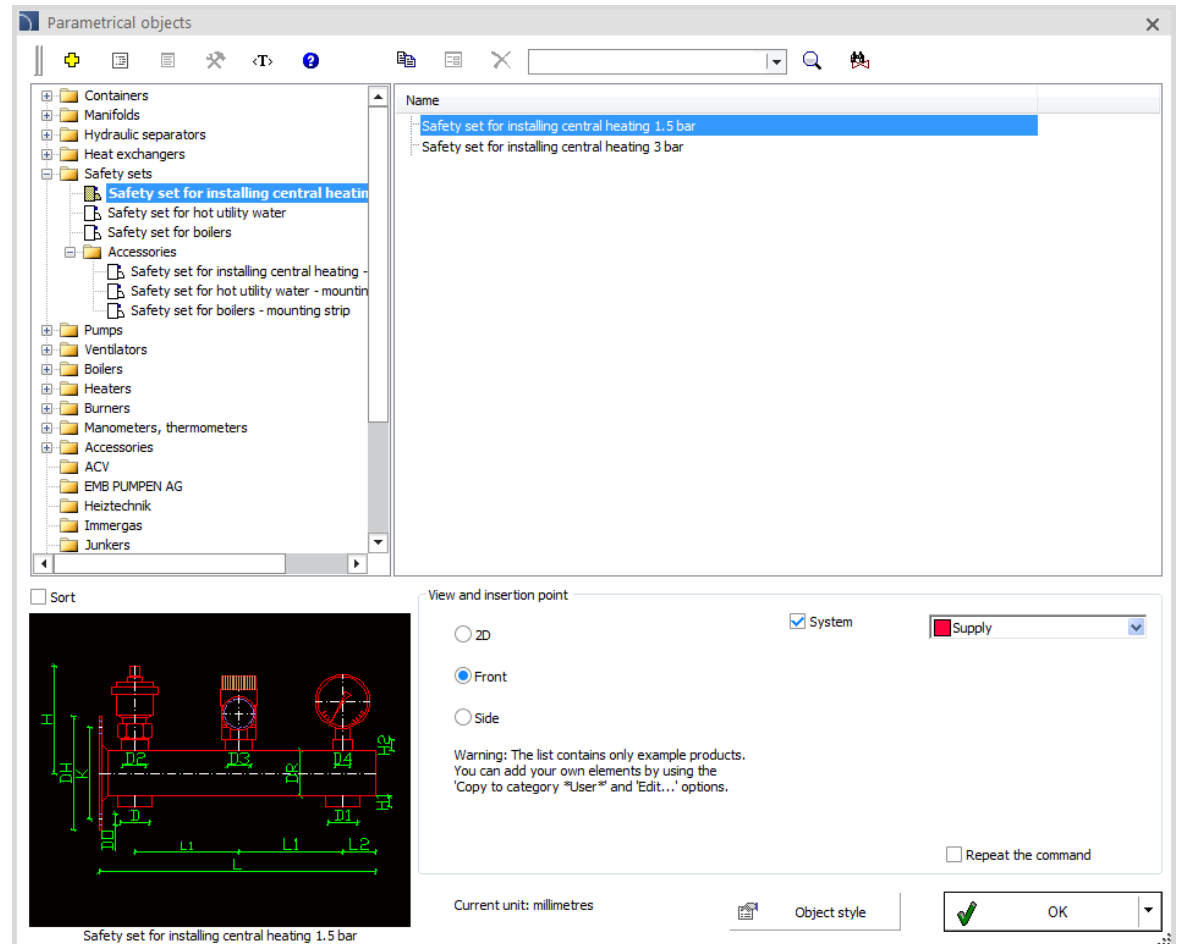



# CADprofi

## ✓ CADprofi HVAC & Piping – additional drawing style for 2D pipelines

Additional drawing style for pipelines in general view (used for example in bent pipes) have been added to the program.



Installation and drawing	
Installation	<input checked="" type="checkbox"/> Supply
Type	Pipe
Manufacturer and type	
	Pipe
	Pipe - style 2

Installation and drawing	
Installation	<input checked="" type="checkbox"/> Supply
Type	Elbow - style 2
Manufacturer and type	
	Elbow
	Elbow - style 2
Manufacturer	Two-segment elbow
	Segmented elbow
Type	



## ✓ CADprofi HVAC & Piping – PE-X Piping system and fittings

PE-X Piping system (with screw and press fittings) have been added to the *Pipes- general views* and *Pipes – detailed views* commands. This system is used in hot and cold water installations, as well as, in central heating.

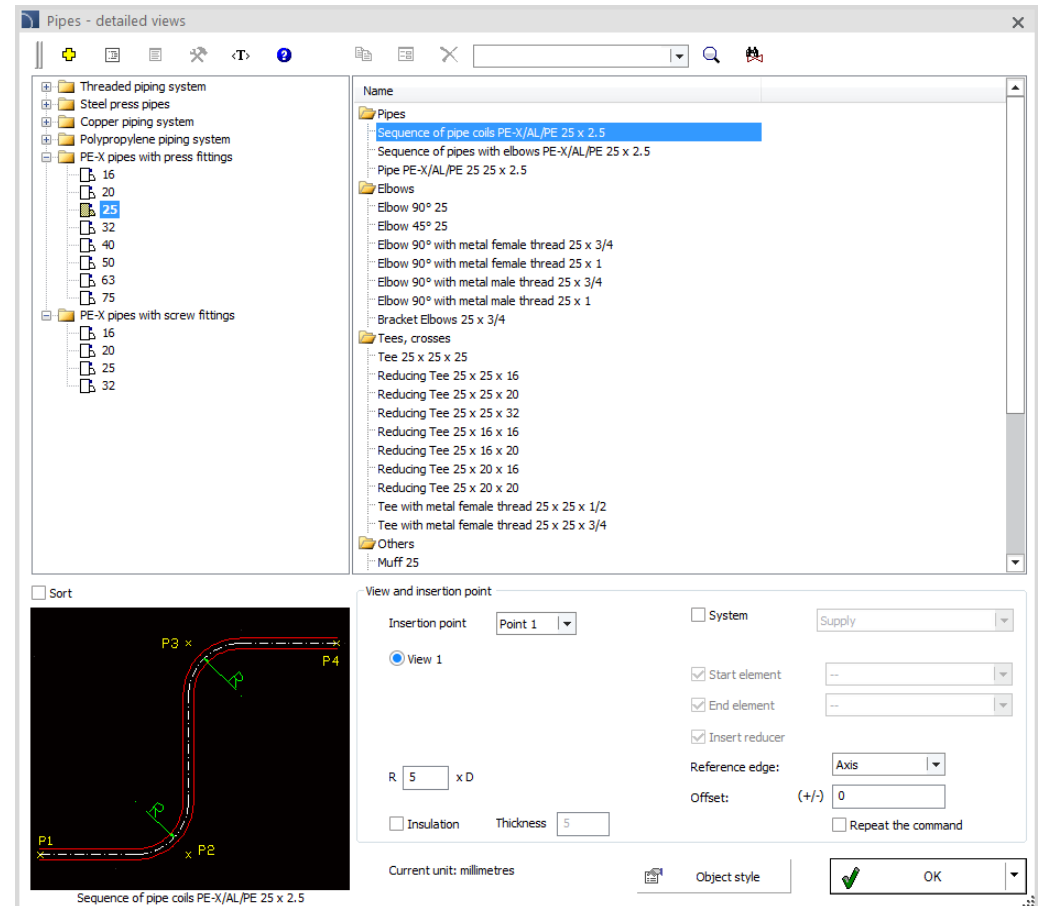
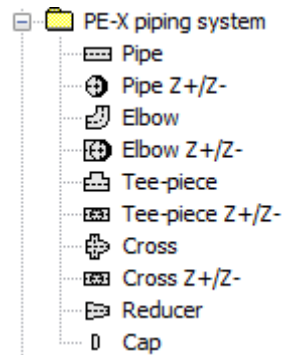

## ✓ CADprofi HVAC & Piping – upgraded insertion of manifolds

In the current program version the definition of manifolds is fully parametric, which makes it easier to define a manifold and its caps. In addition, individual sections can be added to the objects to insert list, allowing user to immediately insert the entire manifold into the drawing.

Additionally a round type and compact hydraulic couplings have been added to the program.

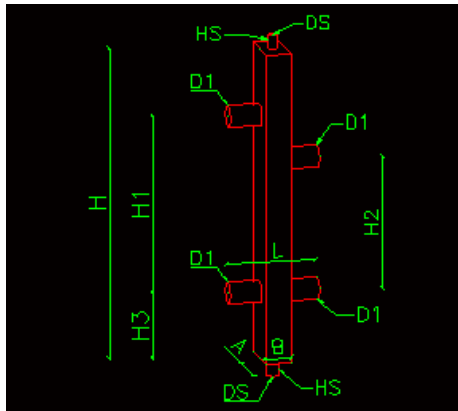
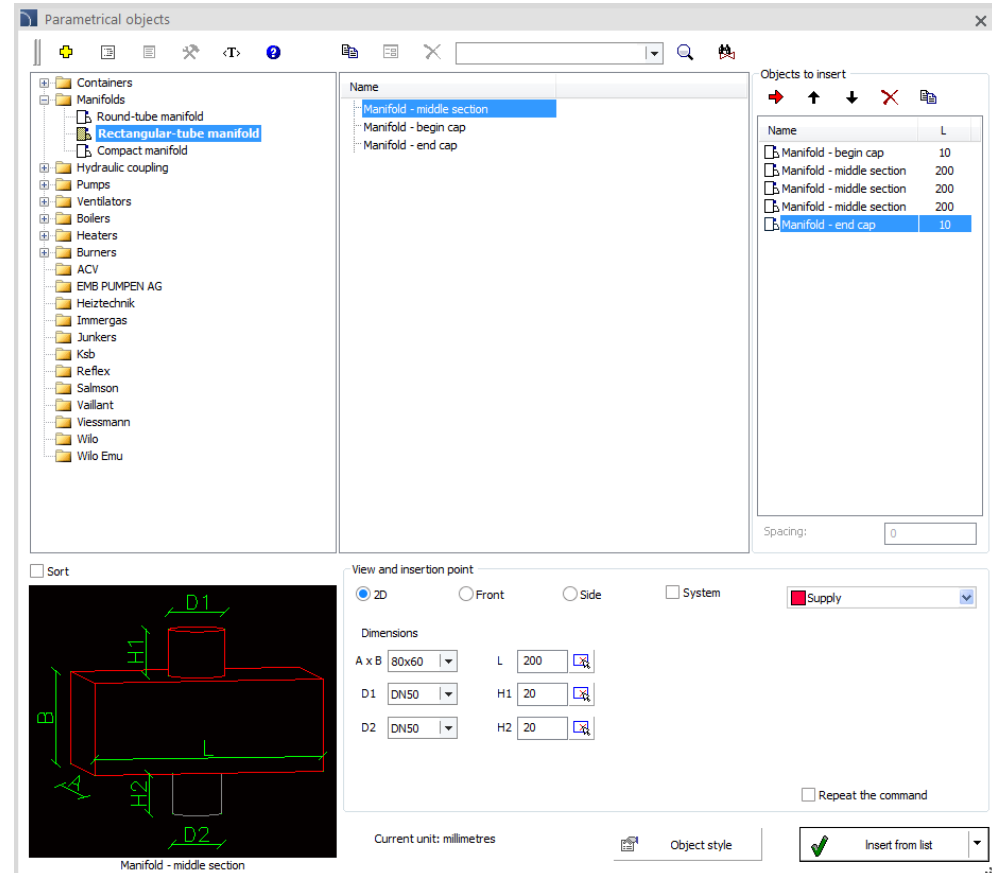
Parametrical objects window showing the insertion of manifold sections. The window displays a tree view of objects, including Containers, Manifolds, Hydraulic coupling, Pumps, Ventilators, Boilers, Heaters, Burners, ACV, BMB PUMPEN AG, Heiztechnik, Immergas, Junkers, Ksb, Reflex, Salmsen, Vaillant, Viessmann, Wilo, and Wilo Emu. The 'Manifolds' folder is expanded, showing 'Round-tube manifold', 'Rectangular-tube manifold', and 'Compact manifold'. The 'Rectangular-tube manifold' folder is selected, and the 'Manifold - middle section' object is highlighted in the 'Objects to insert' list.

The 'Objects to insert' list shows the following items:

Name	L
Manifold - begin cap	10
Manifold - middle section	200
Manifold - middle section	200
Manifold - middle section	200
Manifold - end cap	10

The 'View and insertion point' section shows the following settings:

- View: 2D (selected), Front, Side, System
- Dimensions: A x B: 80x60, L: 200, D1: DN50, D2: DN50, H1: 20, H2: 20
- Repeat the command:
- Current unit: millimetres
- Object style:  Object style
- Insert from list:  Insert from list

## ✓ CADprofi HVAC & Piping – copying dimensions

In pipes and duct in general views an additional *Copy dimensions* option has been added.

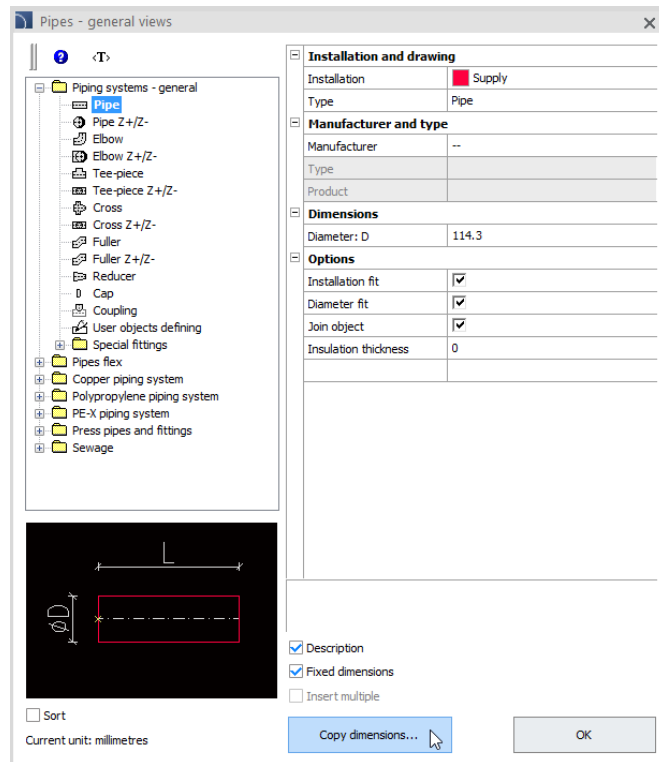

In general views a possibility to retrieve dimensions by right clicking  the mouse button and afterwards have been added to the program. Thanks to this user can:

- Copy dimension by indicating two points:

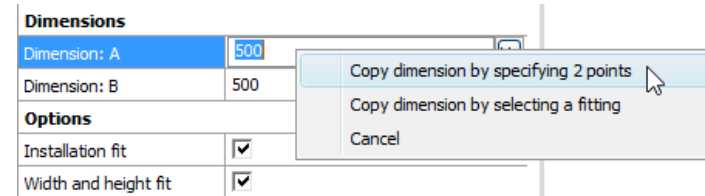

- Copy dimension by selecting a fitting:

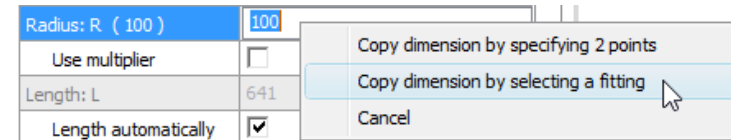



# CADprofi

## ✓ CADprofi HVAC & Piping – drawing insulation in detailed view

The possibility to draw fittings and pipes with insulation in detailed views have been added to the program.

Insulation      Thickness

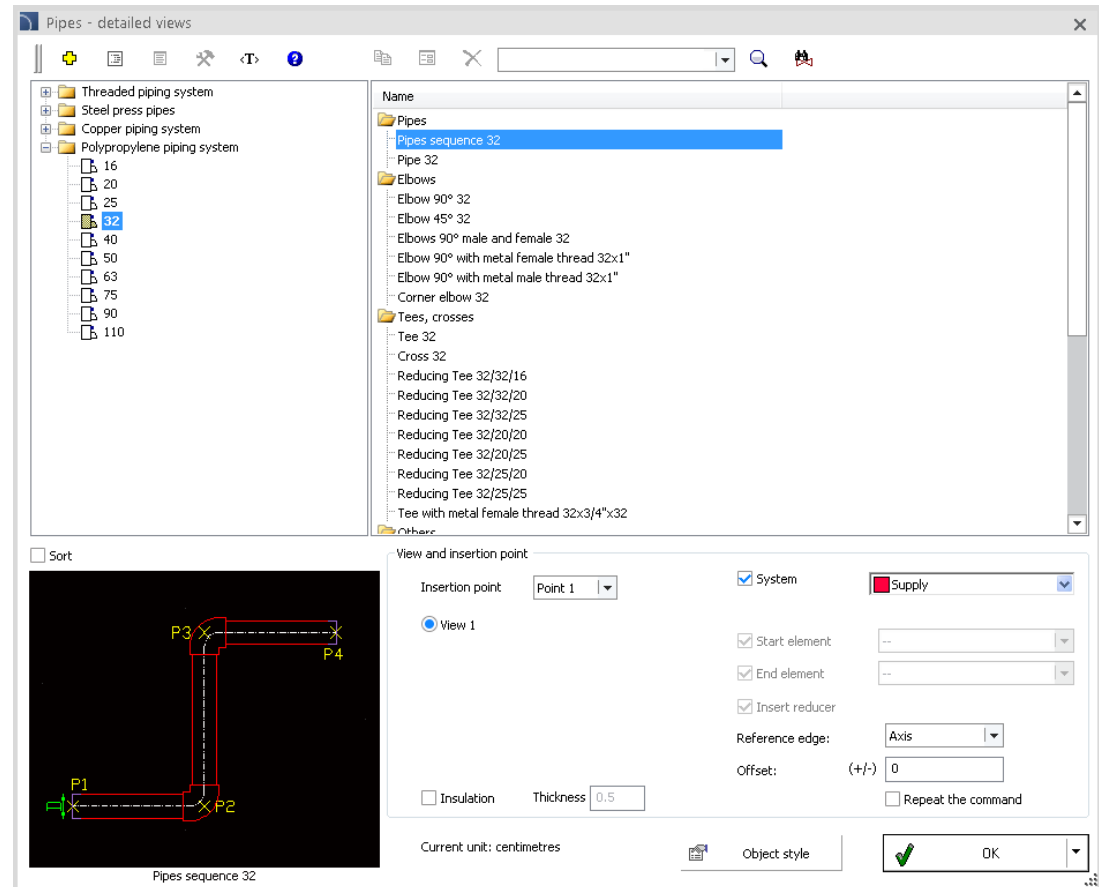

## ✓ New Dehn library

New library that is available in CADprofi program contains surge protection products, including:

- type 1 surge current arresters;
- type 1 surge arresters PV;
- type 2 surge arresters;
- type 2 surge arresters PV;
- type 3 surge arresters;
- coordinated lightning current arresters.

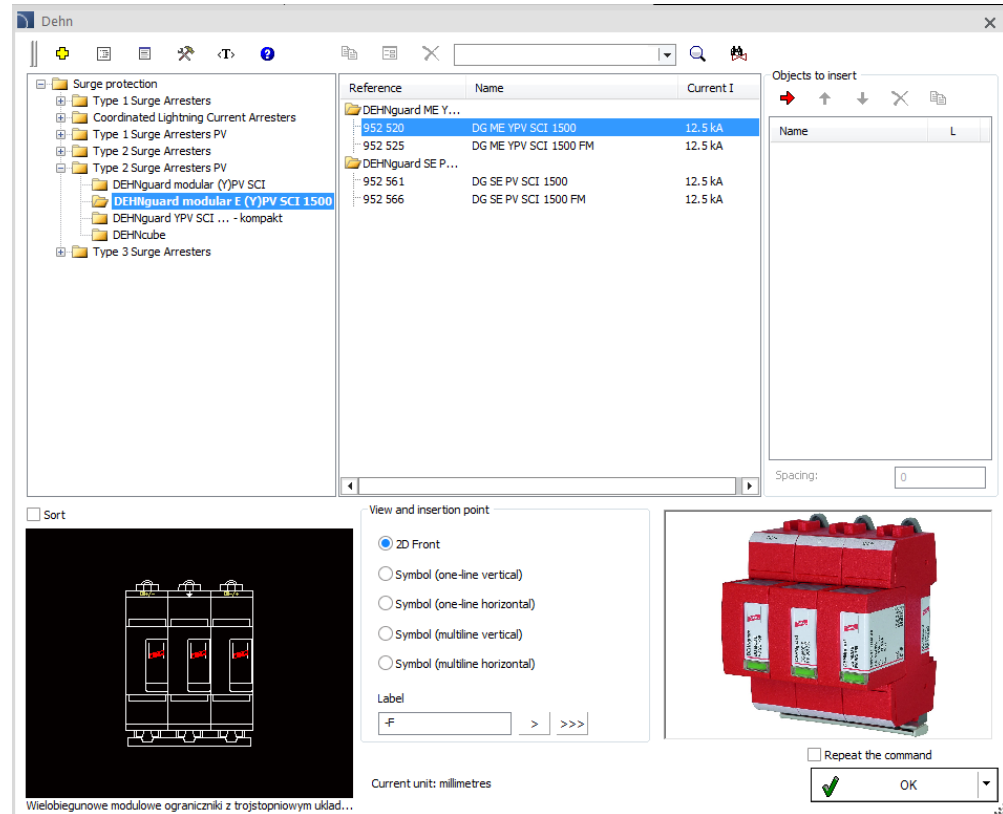

## ✓ Changes in the KaMo library

3-wire housing stations have been added to the program. These stations are also included in comprehensive hydraulic calculations and in the schemes generator.

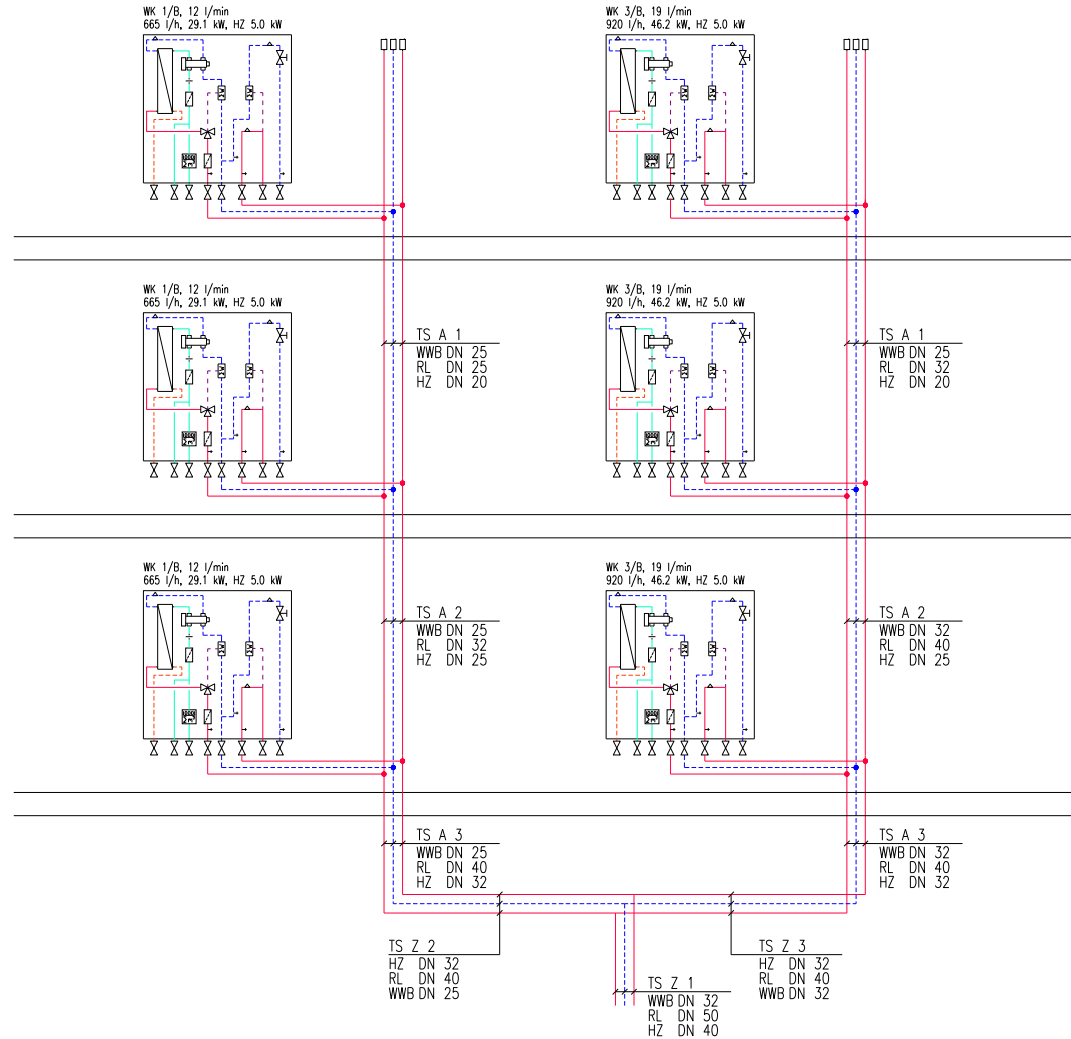

## ✓ New Pulsar library

New Pulsar library that contains covers and power supplies has been added to the program.

Library is available only in Polish language.

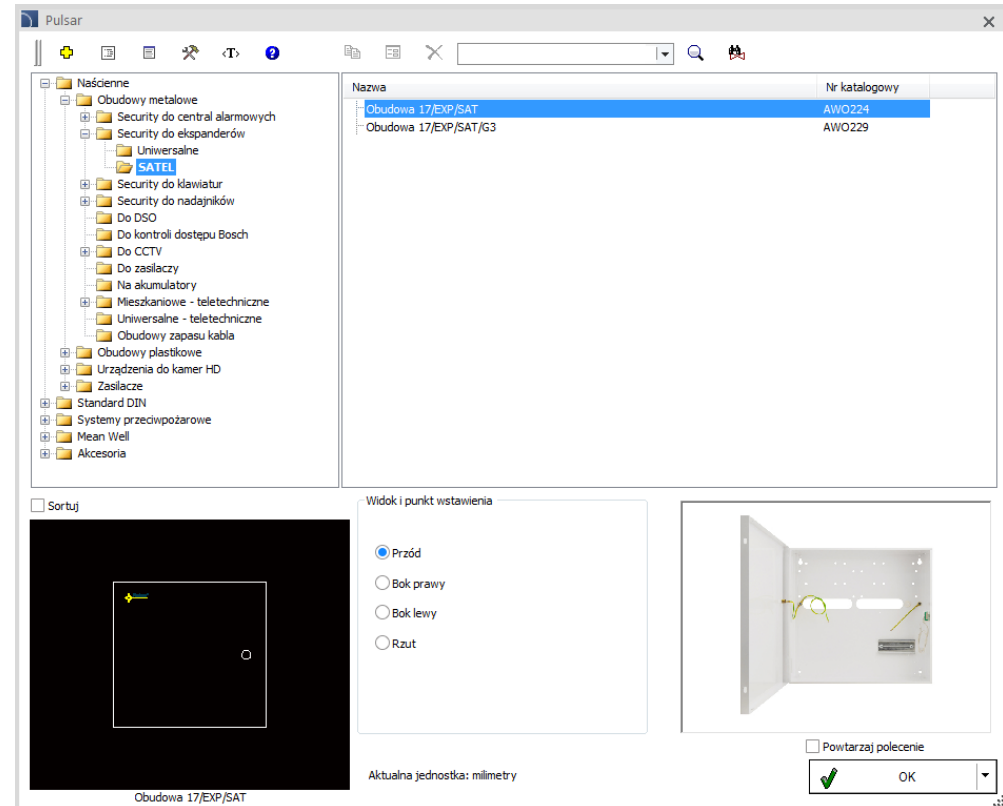



# CADprofi

## ✓ New Pawbol library

New Pawbol library that contains distributors and lighting protection systems has been added to the program.

Library is available only in Polish language.

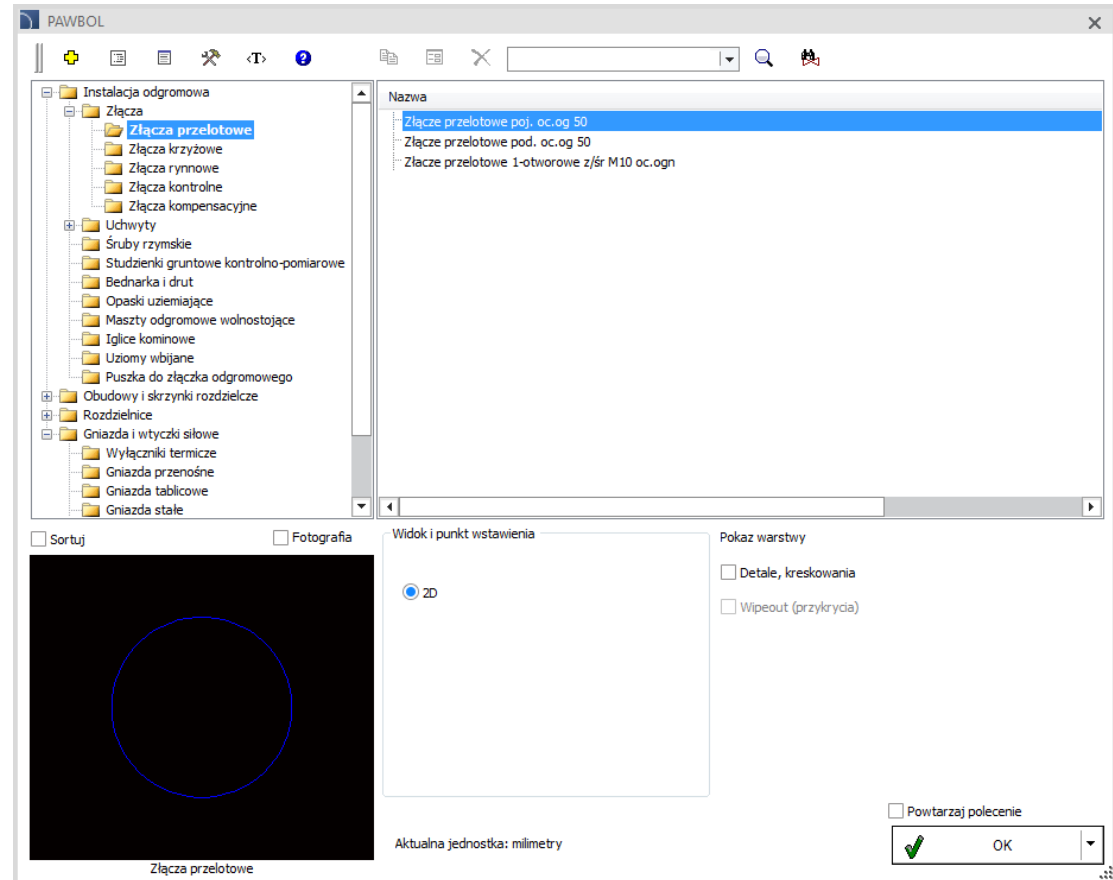



## ✓ New Trilux library

New Trilux library that contains lighting has been added to the program.

Library is available only in Polish language.

In case of importing DIALux stf files that contain Trilux products, then the appropriate lighting from Trilux is being added to the CAD program.



**TRILUX**  
SIMPLIFY YOUR LIGHT.

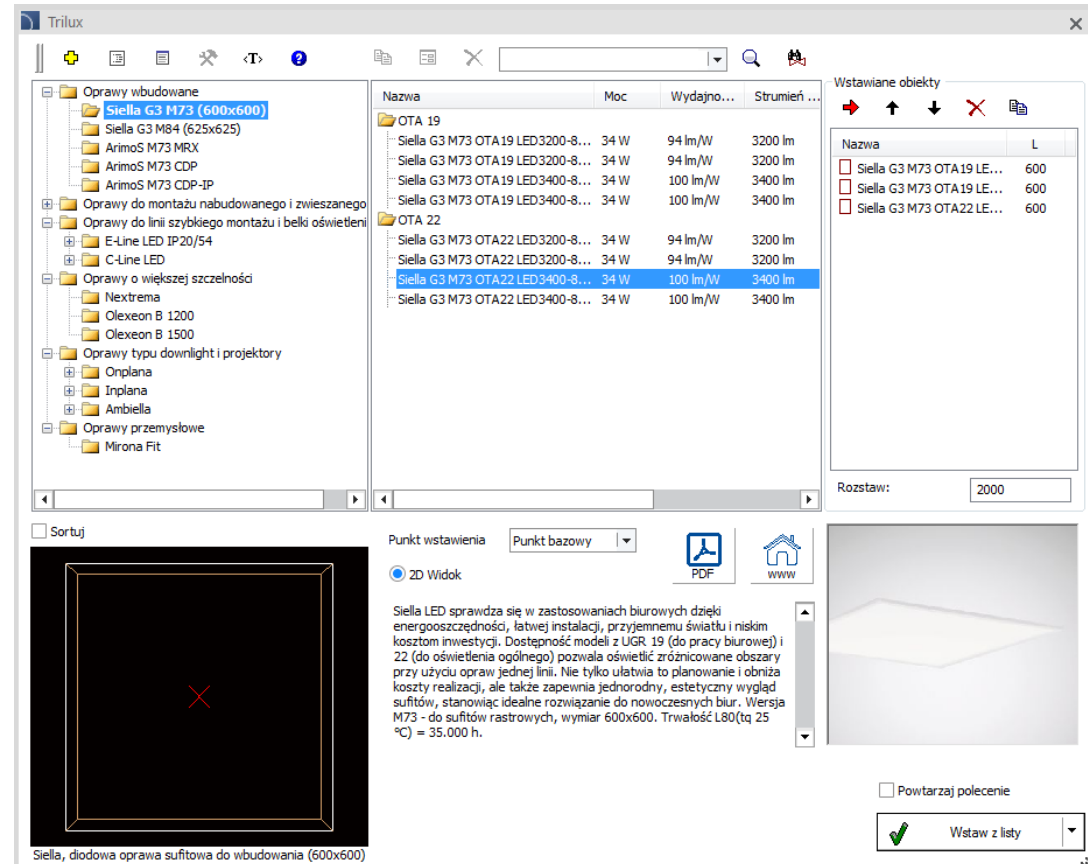

The screenshot shows the Trilux software interface. On the left, there is a tree view of the product library. The main area displays a table of lighting fixtures with columns for Name, Power, Efficiency, and Light Output. Below the table, there is a 2D view of a selected fixture, a 'Wstawiane obiekty' (Insert Objects) panel, and a 'Wstaw z listy' (Insert from List) button.

Nazwa	Moc	Wydajno...	Strumień...
OTA 19			
Siella G3 M73 OTA19 LED3200-8...	34 W	94 lm/W	3200 lm
Siella G3 M73 OTA19 LED3200-8...	34 W	94 lm/W	3200 lm
Siella G3 M73 OTA19 LED3400-8...	34 W	100 lm/W	3400 lm
Siella G3 M73 OTA19 LED3400-8...	34 W	100 lm/W	3400 lm
OTA 22			
Siella G3 M73 OTA22 LED3200-8...	34 W	94 lm/W	3200 lm
Siella G3 M73 OTA22 LED3200-8...	34 W	94 lm/W	3200 lm
Siella G3 M73 OTA22 LED3400-8...	34 W	100 lm/W	3400 lm
Siella G3 M73 OTA22 LED3400-8...	34 W	100 lm/W	3400 lm

Wstawiane obiekty

Nazwa	L
<input type="checkbox"/> Siella G3 M73 OTA19 LE...	600
<input type="checkbox"/> Siella G3 M73 OTA19 LE...	600
<input type="checkbox"/> Siella G3 M73 OTA22 LE...	600

Rozstaw: 2000

Siella LED sprawdza się w zastosowaniach biurowych dzięki energooszczędności, łatwej instalacji, przyjemnemu światłu i niskim kosztom inwestycji. Dostępność modeli z UGR 19 (do pracy biurowej) i 22 (do oświetlenia ogólnego) pozwala oświetlić zróżnicowane obszary przy użyciu opraw jednej linii. Nie tylko ułatwia to planowanie i obniża koszty realizacji, ale także zapewnia jednnorodny, estetyczny wygląd sufitów, stanowiąc idealne rozwiązanie do nowoczesnych biur. Wersja M73 - do sufitów rastrowych, wymiar 600x600. Trwałość L80(tq 25 °C) = 35.000 h.

Wstaw z listy

## ✓ New ABB library

An intuitive and easy to use ABB library automates the design of electrical installations using ABB products. Library is currently translated in Polish and in English. More languages will come soon.

ABB library includes the following categories:

- Low voltage apparatus and cabinets contains a complete library of ABB products, including: modular and measuring apparatus, photovoltaics, circuit breakers and disconnectors, ABB i-bus KNX and ABB free@home® system devices, cabinets and others.
- Power distribution schemes creator that allows to easily create an electrical installation project with ABB products.
- Low voltage systems that includes products from the call ABB SIGNAL and video intercom ABB WELCOME systems.
- Low voltage systems that includes exemplary schemes: ABB i-bus KNX, ABB free@home®, ABB SIGNAL and ABB WELCOME.

[Watch ABB library movie](#)

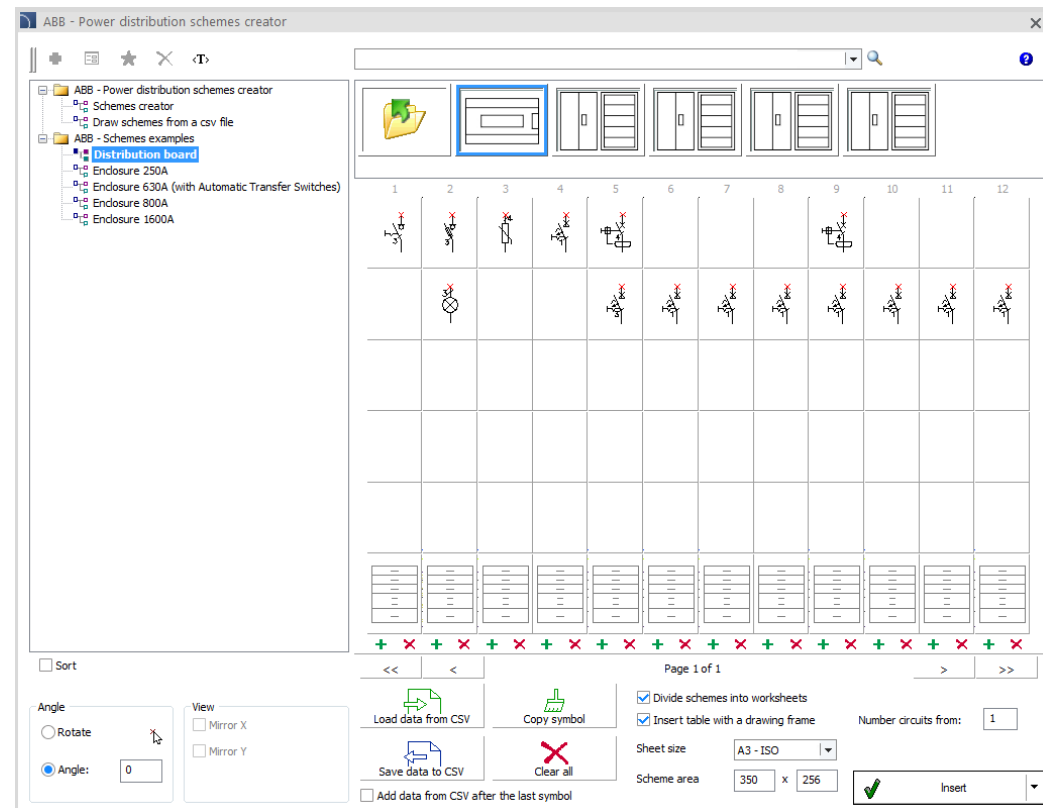

## ✓ ELKO-BIS – updated library for lightning protection design

New features in ELKO-BIS:

- Update of ELKO-BIS company products.
- A new products filtering creator that allows user to easily select the right product, starting from choosing the LPS protection class to the type of roofing and the lightning protection materials.
- Easier selection of accessories, handles etc.
- Parametric definition of object protection zone (protected by masts and needles).
- Dynamic creator of legends.

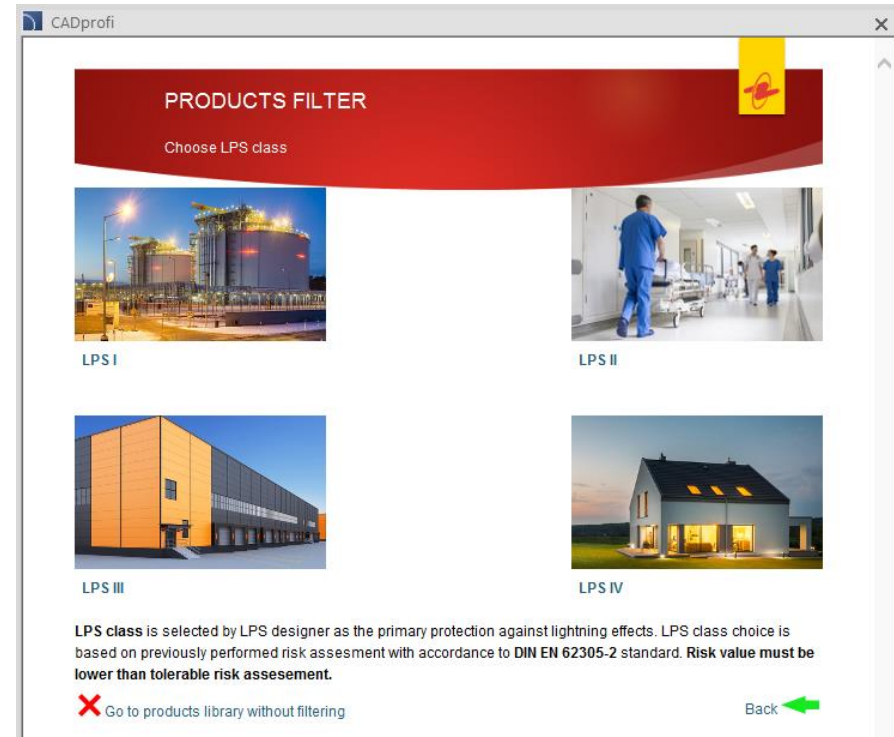
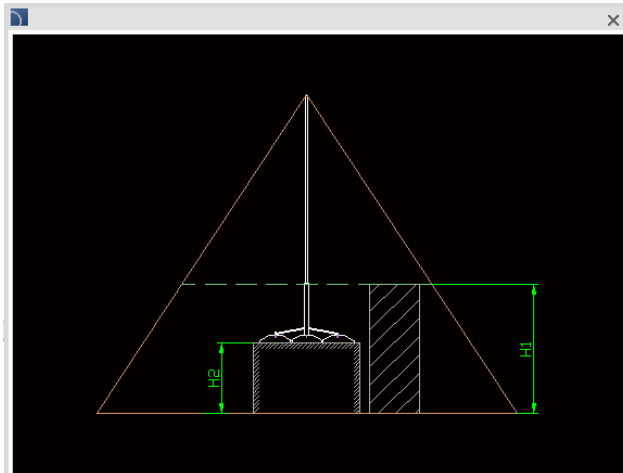



# CADprofi

✓ Update of manufacturers' libraries:





# CADprofi

## ✓ Adjustment to many base CAD programs

CADprofi 2018 has been adjusted to work with latest CAD programs, including: ArCADia PLUS 10.3, AutoCAD 2018, BricsCAD V18, CADian 2017, CMS IntelliCAD 8.3, GstarCAD 2017 SP1, GstarCAD 2018, progeCAD 2018, ZWCAD 2018.

CADprofi 2018 currently works with many base CAD programs including: AutoCAD (since the 2000 version), BricsCAD, GstarCAD, IntelliCAD, progeCAD, ZWCAD, ARES Commander Edition and others.

The logo for AutoCAD, consisting of the word "AutoCAD" in a bold, red, sans-serif font with a registered trademark symbol.

The logo for ZWCAD, featuring the letters "ZWCAD" in a bold, blue, sans-serif font with a green leaf-like graphic above the "W".

The logo for GstarCAD, with "Gstar" in blue and "CAD" in yellow, followed by the tagline "An Alternative CAD System" in blue.

The logo for BricsCAD, featuring a stylized blue "B" shape above the word "BRICSCAD" in a bold, blue, sans-serif font.

The logo for progeSOFT, featuring a blue globe with a yellow vertical bar and a yellow triangle above it, with the text "progeSOFT" below.

The logo for IntelliCAD, featuring a purple diamond shape with a yellow vertical bar and a yellow triangle above it, with the text "IntelliCAD" below.